

Pool Number of

Date: _____

Event: _____

Venue: _____

Category: _____

Duration of Contests Minutes

Name														Contest	
Grade														Duration	
Club/Area															
Pool of	3	4	5	Red/Blue	White	Red/Blue	White	Red/Blue	White	Red/Blue	White	Red/Blue	White	Mins	Secs
			1												
1	1		2												
		2	3												
			4												
2	3		5												
			6												
		4	7												
			8												
3	6		9												
			10												
Total Points															
Total Wins															
Position															
Promotion Points	This Pool		This Pool		This Pool		This Pool		This Pool		This Pool		This Pool		

- T** Win by an Ippon Throw 10
- H** Win by an Ippon Hold 10
- C** Win by a Choke/Strangle 10
- L** Win by an Arm/Elbow Lock 10
- T** Win by a Waza-Ari Throw 7
- H** Win by a Waza-Ari Hold 7
- S** Win by Superiority (Koka, Yuko or Hantei) 3 or 5 or 1
- FG** Win by Fusen-Gachi (Non-appearance of opponent) 0
- KG** Win by a Kiken-Gachi (Withdrawal of opponent due to injury) 10
- SG** Win by Segu-Gachi (Compound Win) 10
- HM** Win by Hansoku-Make (Direct) 10
- △** Win by Hansoku-Make (Accumulated) 10
- △** Win by a Penalty (Shido, Chui, Keikoku Against Opponent) 7 or 5 or 3
- D** Drawn Contest 0
- L** Loss of Contest 0

Table Officials _____

Referees _____

Finals Table

Date: _____
 Event: _____
 Venue: _____
 Category: _____

Duration of Contests _____ Minutes

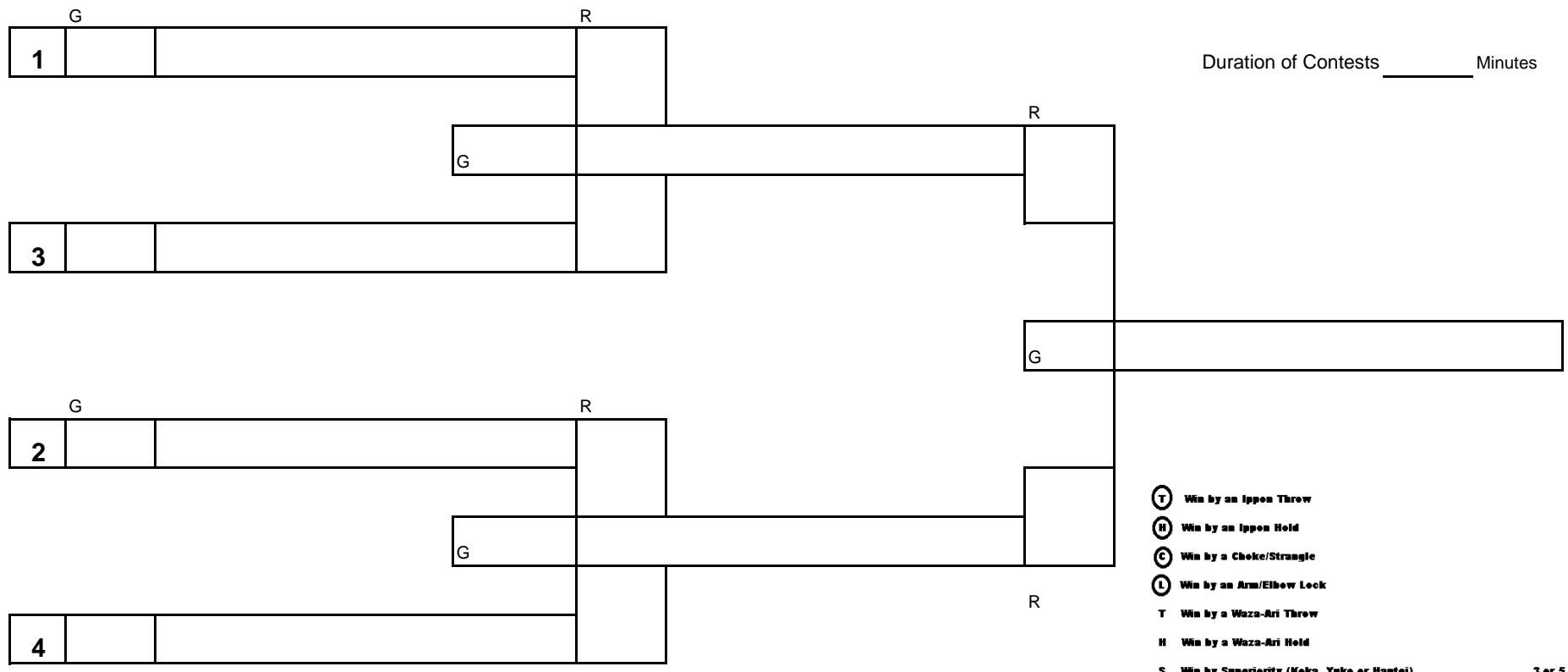

Table Officials _____

 Referees _____

Ⓙ	Win by an Ippon Throw	10
Ⓜ	Win by an Ippon Hold	10
Ⓒ	Win by a Choke/Strangle	10
Ⓛ	Win by an Arm/Elbow Lock	10
T	Win by a Waza-Ari Throw	7
H	Win by a Waza-Ari Hold	7
S	Win by Superiority (Koka, Yuke or Hantei)	3 or 5 or 1
FG	Win by Fusen-Gachi (Non-appearance of opponent)	0
KG	Win by a Kiken-Gachi (Withdrawal of opponent due to injury)	10
SG	Win by Segoe-Gachi (Compound Win)	10
HM	Win by Hansoku-Make (Direct)	10
⚠	Win by Hansoku-Make (Accumulated)	10
⚠	Win by a Penalty (Shido, Chui, Keikoku Against Opponent)	7 or 5 or 3
D	Drawn Contest	0
L	Loss of Contest	0

Knockout Sheet for 5 to 8 Players

Date: _____

Event: _____

Venue: _____

Category: _____

Duration of Contests _____ Minutes

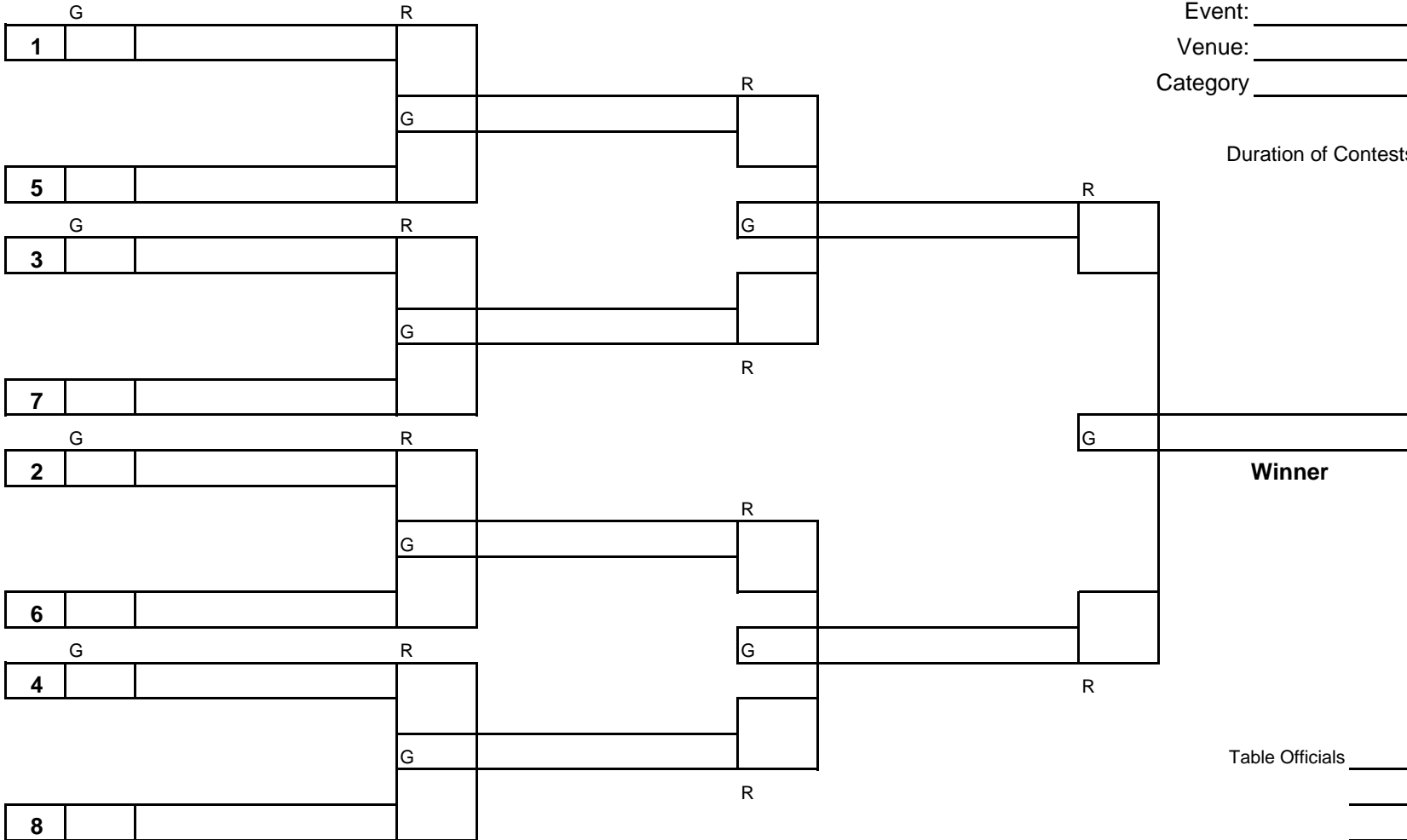
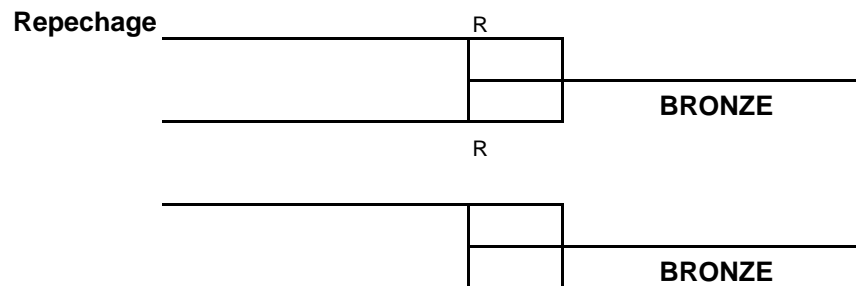

Table Officials _____

Referees _____



Repechage Section of Knockout Table for 17 to 32 Players

Date: _____
 Event: _____
 Venue: _____
 Category: _____
 Duration of Contests: _____ Minutes

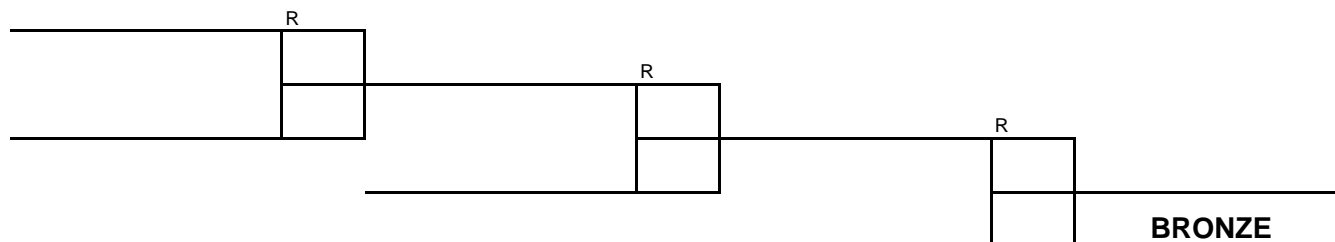
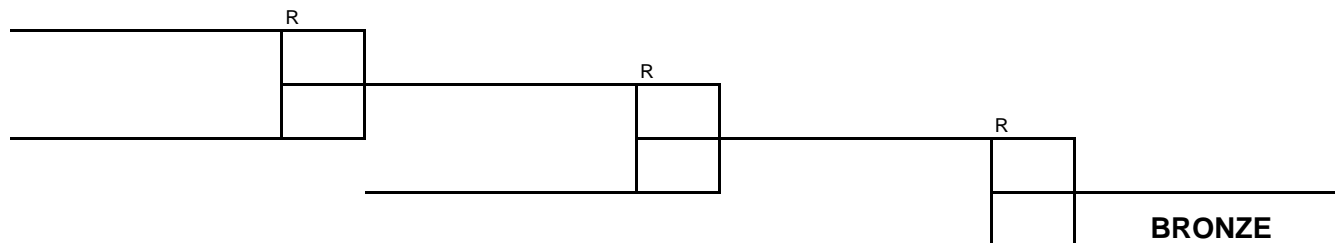
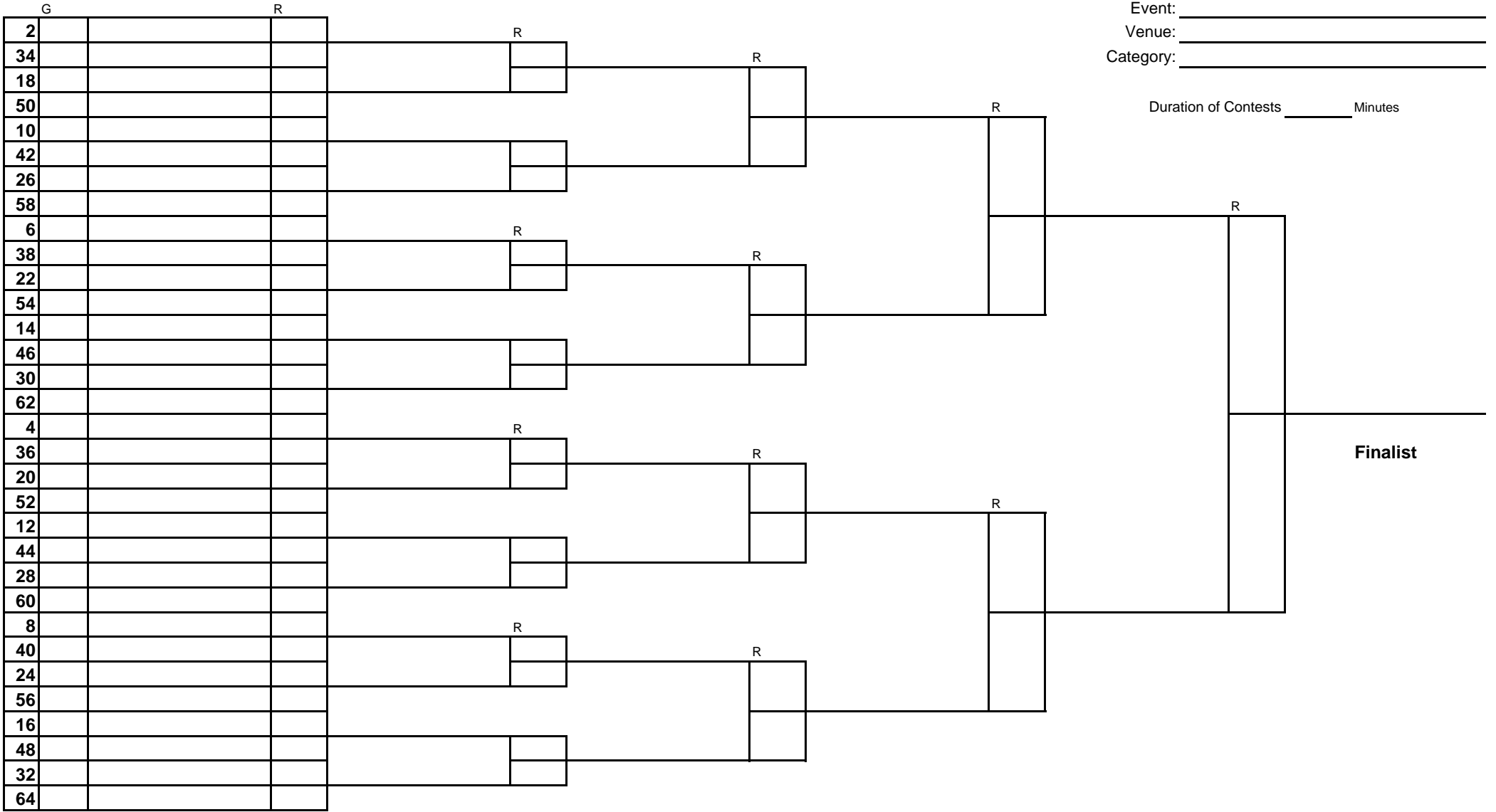

Table Officials _____

Referees _____

- Ⓣ Win by an Ippen Throw 10
- Ⓜ Win by an Ippen Hold 10
- Ⓒ Win by a Choke/Strangle 10
- Ⓛ Win by an Arm/Elbow Lock 10
- T Win by a Waza-Ari Throw 7
- H Win by a Waza-Ari Hold 7
- S Win by Superiority (Koka, Yuko or Hantei) 3 or 5 or 1
- FG Win by Fusen-Gachi (Non-appearance of opponent) 0
- KG Win by a Kiken-Gachi (Withdrawal of opponent due to injury) 10
- SG Win by Sego-Gachi (Compound Win) 10
- HM Win by Hansoku-Make (Direct) 10
- ⚠ Win by Hansoku-Make (Accumulated) 10
- ⚠ Win by a Penalty (Shido, Chui, Keikoku Against Opponent) 7 or 5 or 3
- D Drawn Contest 0
- L Loss of Contest 0

Knockout Table for 33 to 64 Players



Date: _____
 Event: _____
 Venue: _____
 Category: _____

Duration of Contests _____ Minutes

Table Officials _____

Referees _____

Repechage Section of Knockout for 33 to 64 Players

Date: _____
 Event: _____
 Venue: _____
 Category: _____

Duration of Contests _____ Minutes

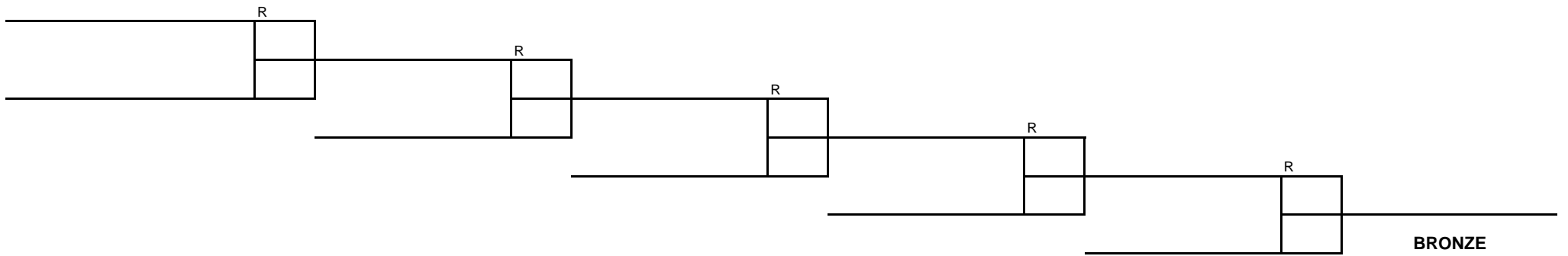
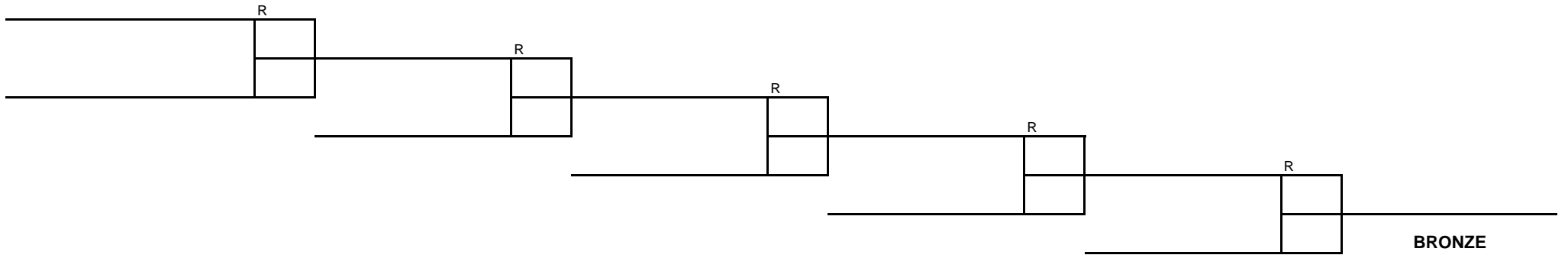
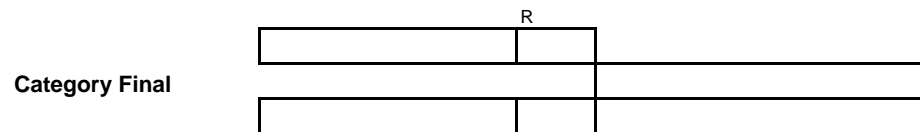

Table Officials _____

Referees _____



Knockout for 65 to 128 Players

Date: _____
 Event: _____
 Venue: _____
 Category: _____

SECTION A

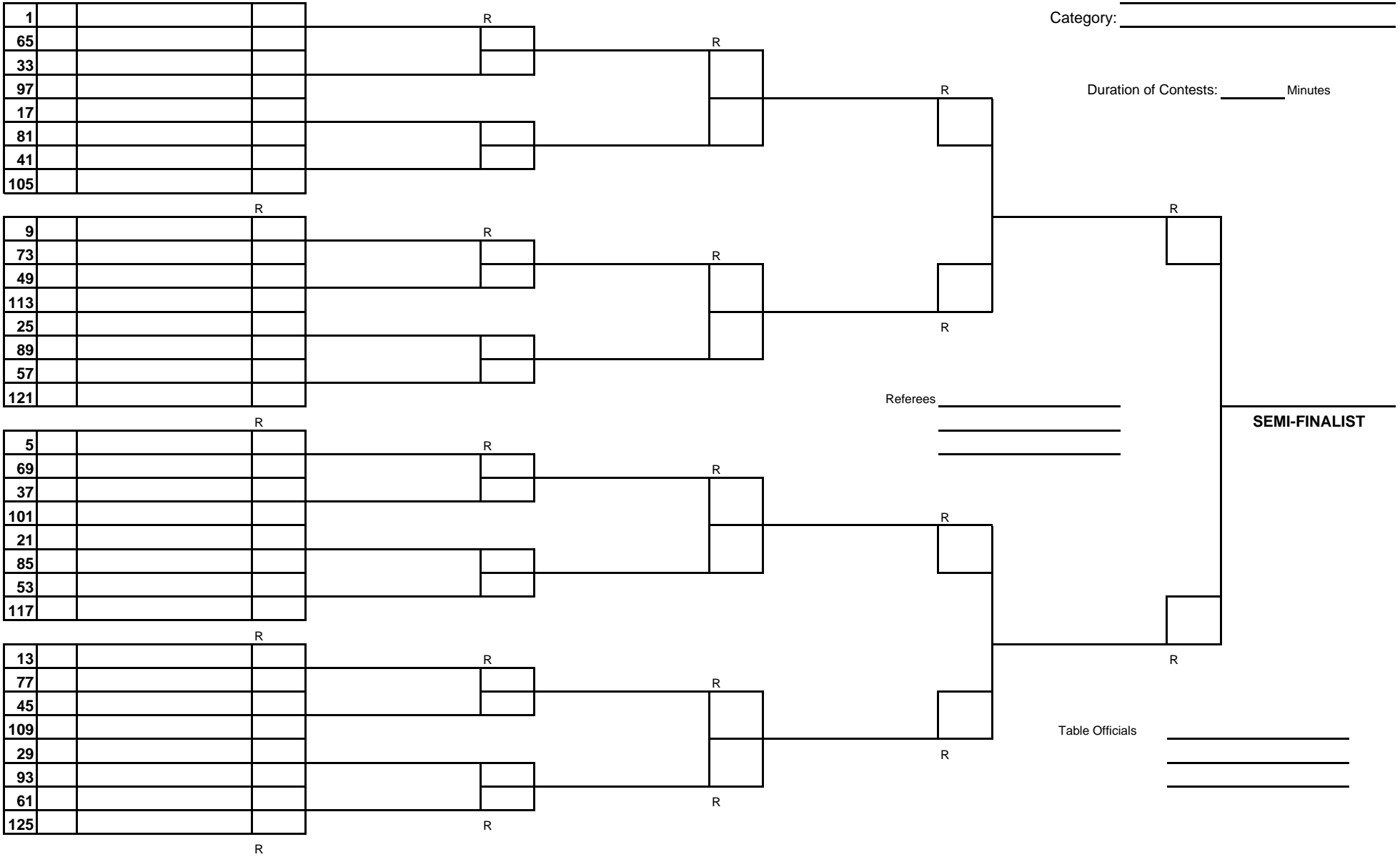

Knockout for 65 to 128 Players

Date: _____
 Event: _____
 Venue: _____
 Category: _____

SECTION B

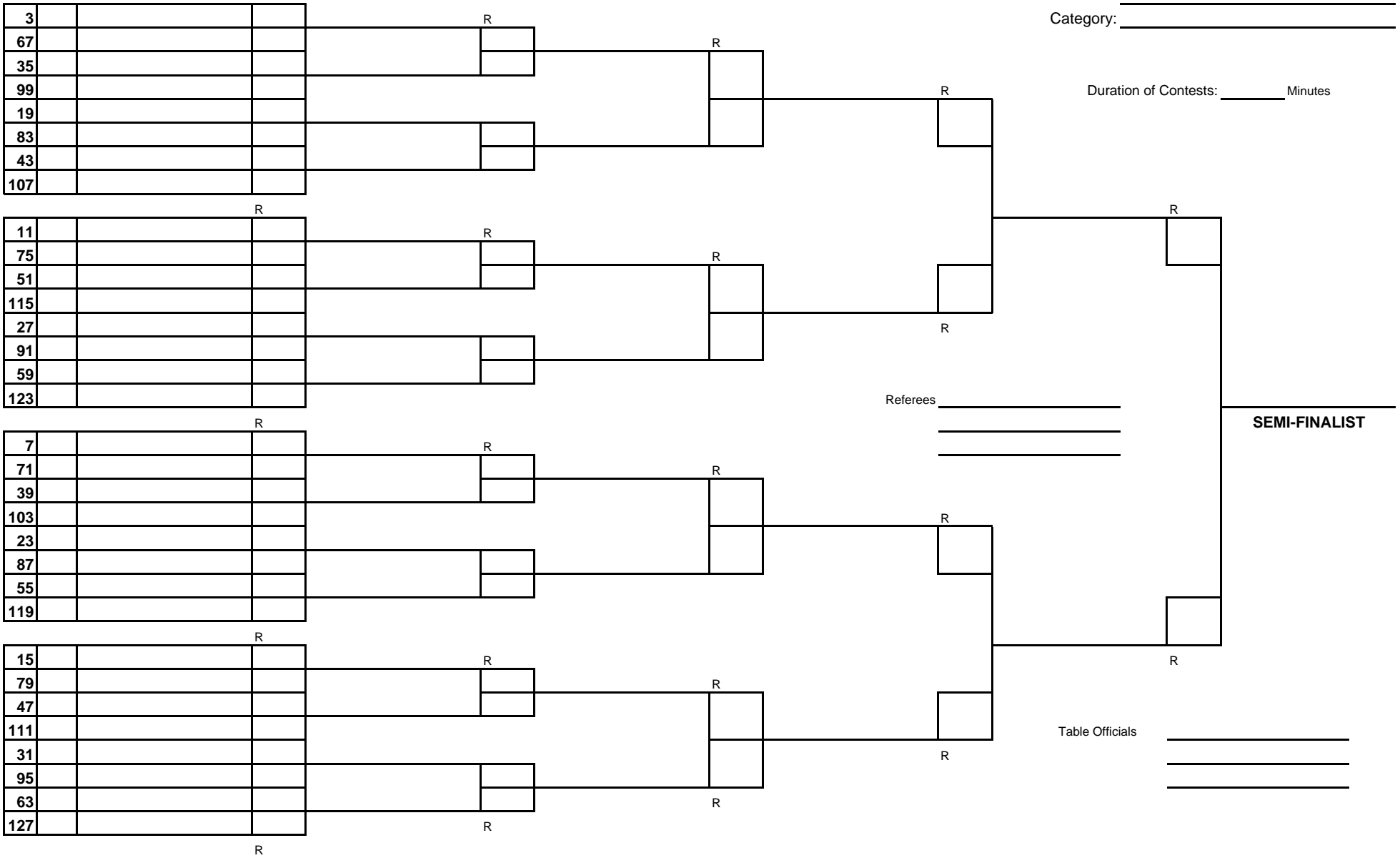

Knockout and for 65 to 128 Players

Date: _____
 Event: _____
 Venue: _____
 Category: _____

SECTION C

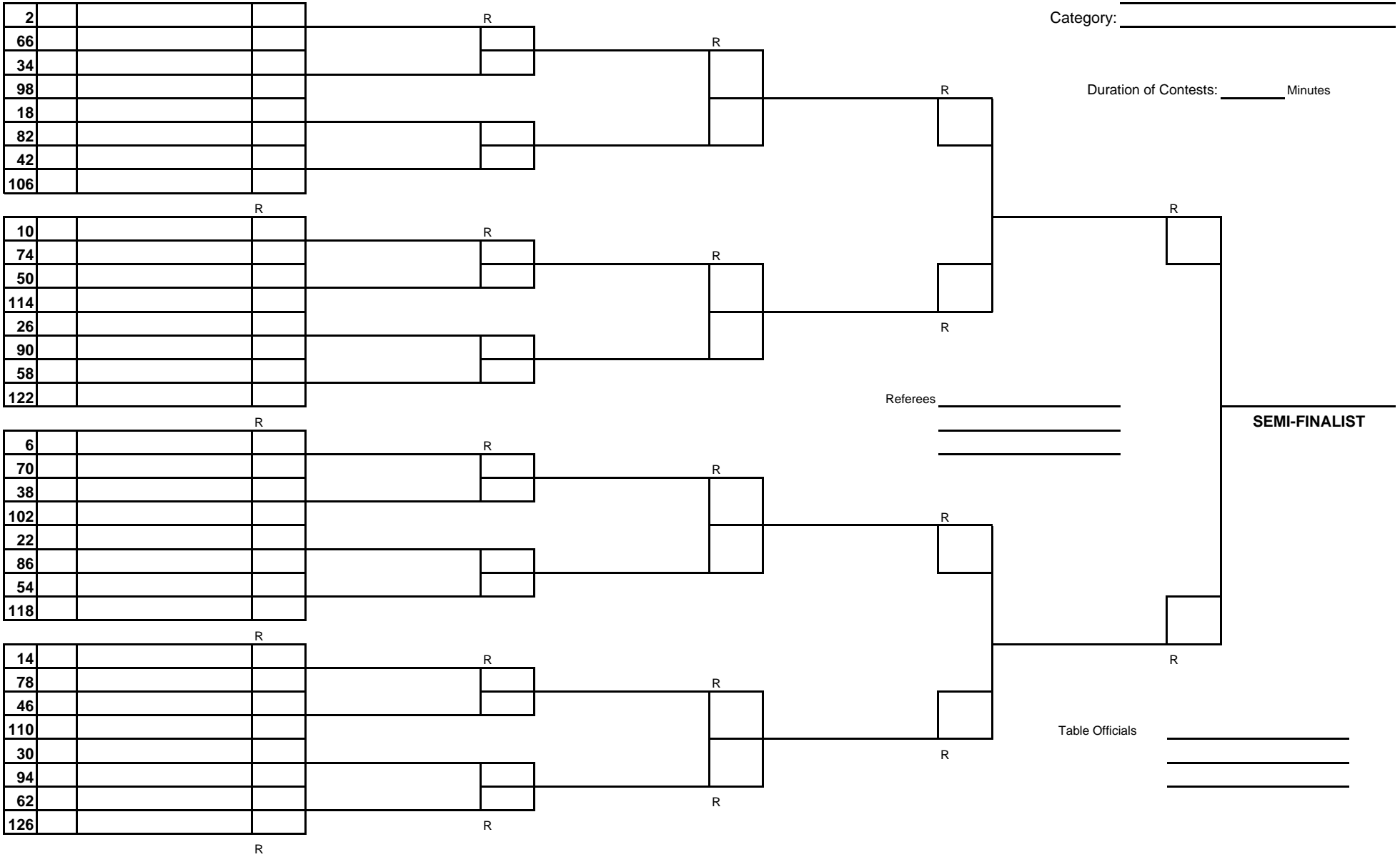

Knockout for 65 to 128 Players

Date: _____
 Event: _____
 Venue: _____
 Category: _____

SECTION D

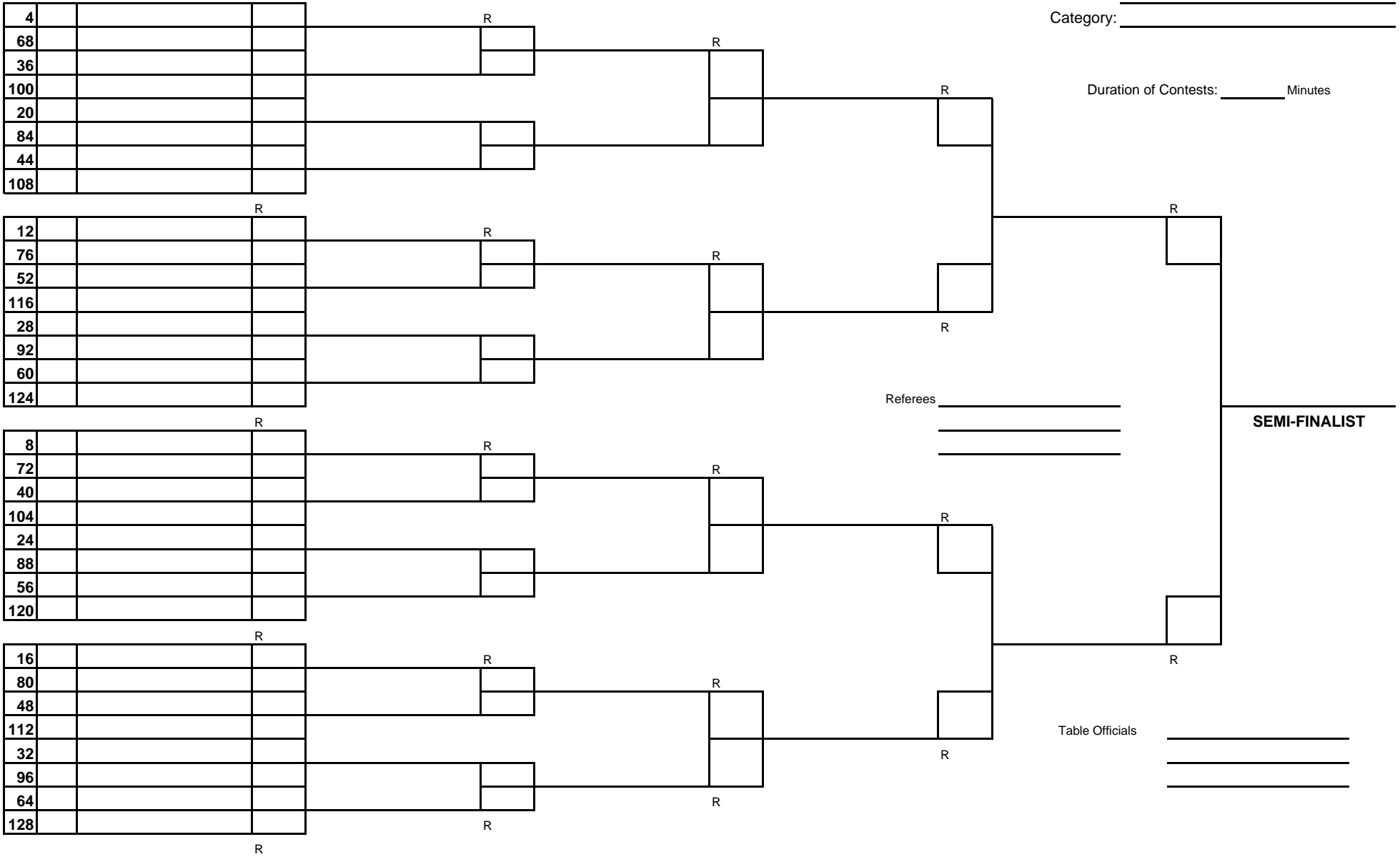

SEMI-FINALS AND FINAL TABLE of Knockout for 65 to 128 Players

Date: _____
 Event: _____
 Venue: _____
 Category: _____

Duration of Contests: _____ Minutes

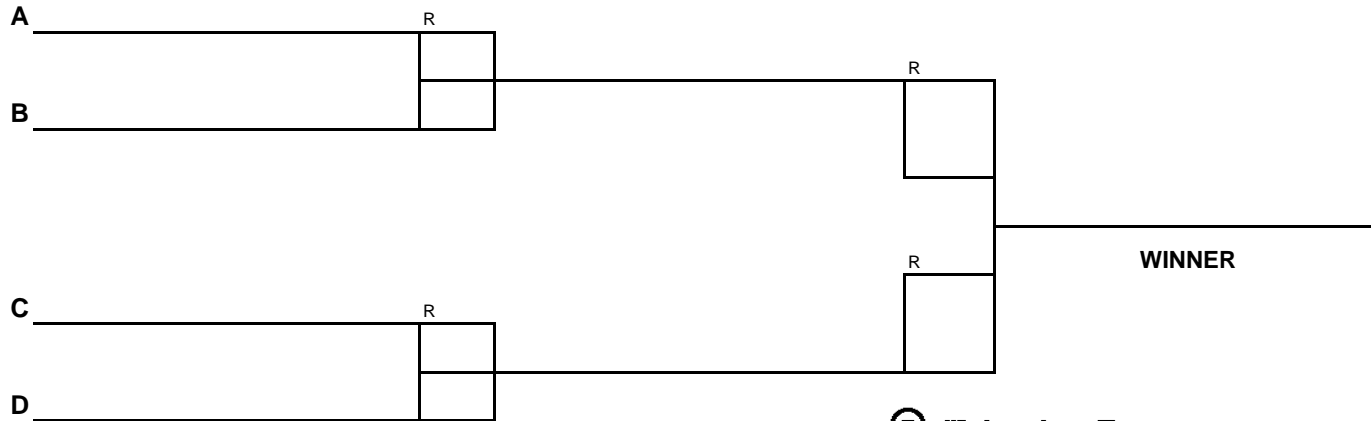

Table Officials _____

Referees _____

- Ⓣ Win by an Ippon Throw 10
- ⓓ Win by an Ippon Hold 10
- Ⓒ Win by a Choke/Strangle 10
- Ⓛ Win by an Arm/Elbow Lock 10
- T Win by a Waza-Ari Throw 7
- H Win by a Waza-Ari Hold 7
- S Win by Superiority (Koka, Yuku or Hantei) 3 or 5 or 1
- FG Win by Fusen-Gachi (Non-appearance of opponent) 0
- KG Win by a Kiken-Gachi (Withdrawal of opponent due to injury) 10
- SG Win by Sege-Gachi (Compound Win) 10
- HM Win by Hansoku-Make (Direct) 10
- △ Win by Hansoku-Make (Accumulated) 10
- ▽ Win by a Penalty (Shido, Chui, Keikoku Against Opponent) 7 or 5 or 3
- D Drawn Contest 0
- L Less of Contest 0

Repechage for Knockout 65 to 128 Players

Date: _____

Duration of Contests: _____ Minutes

Event: _____

Venue: _____

Category: _____

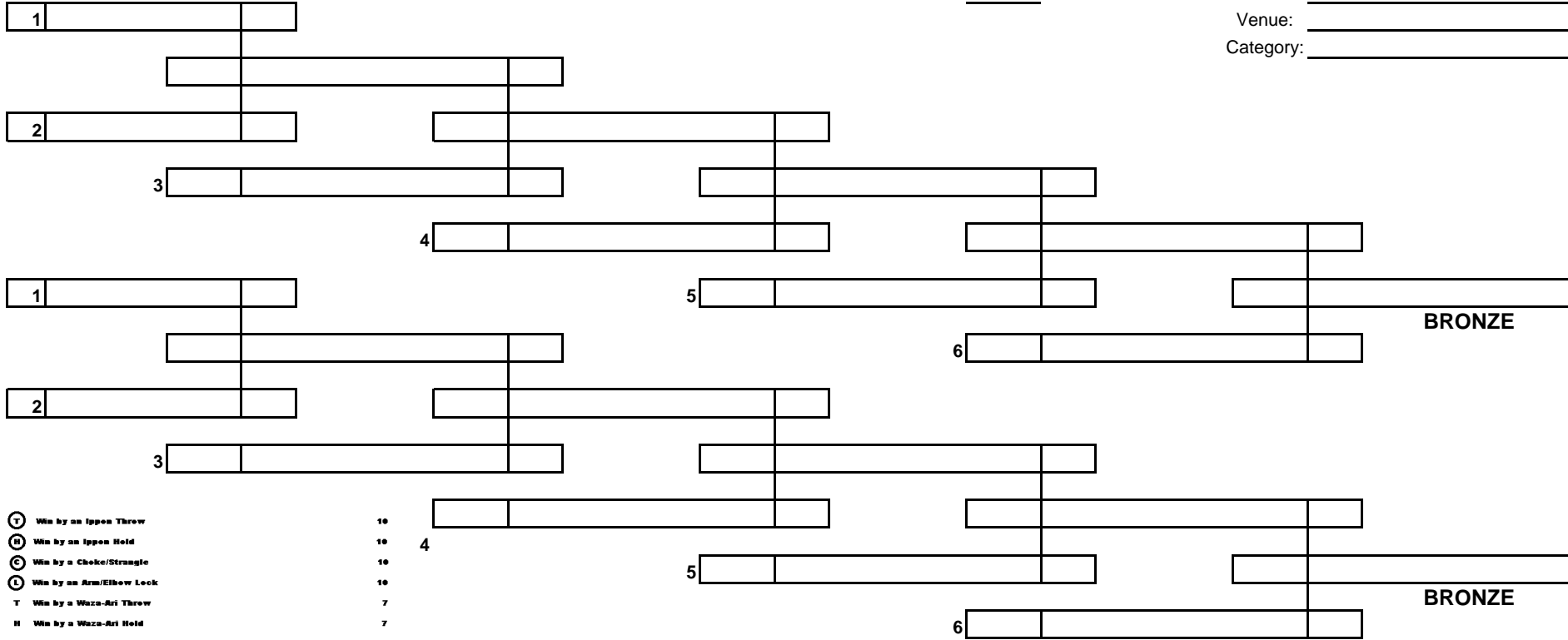

- ⑦ Win by an Ippon Throw 10
- ⑧ Win by an Ippon Hold 10
- ⑨ Win by a Choke/Strangle 10
- ⑩ Win by an Arm/Elbow Lock 10
- T Win by a Waza-Ari Throw 7
- H Win by a Waza-Ari Hold 7
- S Win by Superiority (Koka, Yuko or Hantei) 3 or 5 or 1
- FG Win by Fusen-Gachi (Non-appearance of opponent) 0
- KG Win by a Kiken-Gachi (Withdrawal of opponent due to injury) 10
- SG Win by Sogo-Gachi (Compound Win) 10
- NM Win by Hansoku-Make (Direct) 10
- △ Win by Hansoku-Make (Accumulated) 10
- ▲ Win by a Penalty (Shido, Chui, Keikoku Against Opponent) 7 or 5 or 3
- D Drawn Contest 0
- L Loss of Contest 0

Referees _____

Table Officials _____

Double Knockout Sheet for 5 to 8 Players

Date: _____

Event: _____

Venue: _____

Category _____

Duration of Contests _____ Minutes

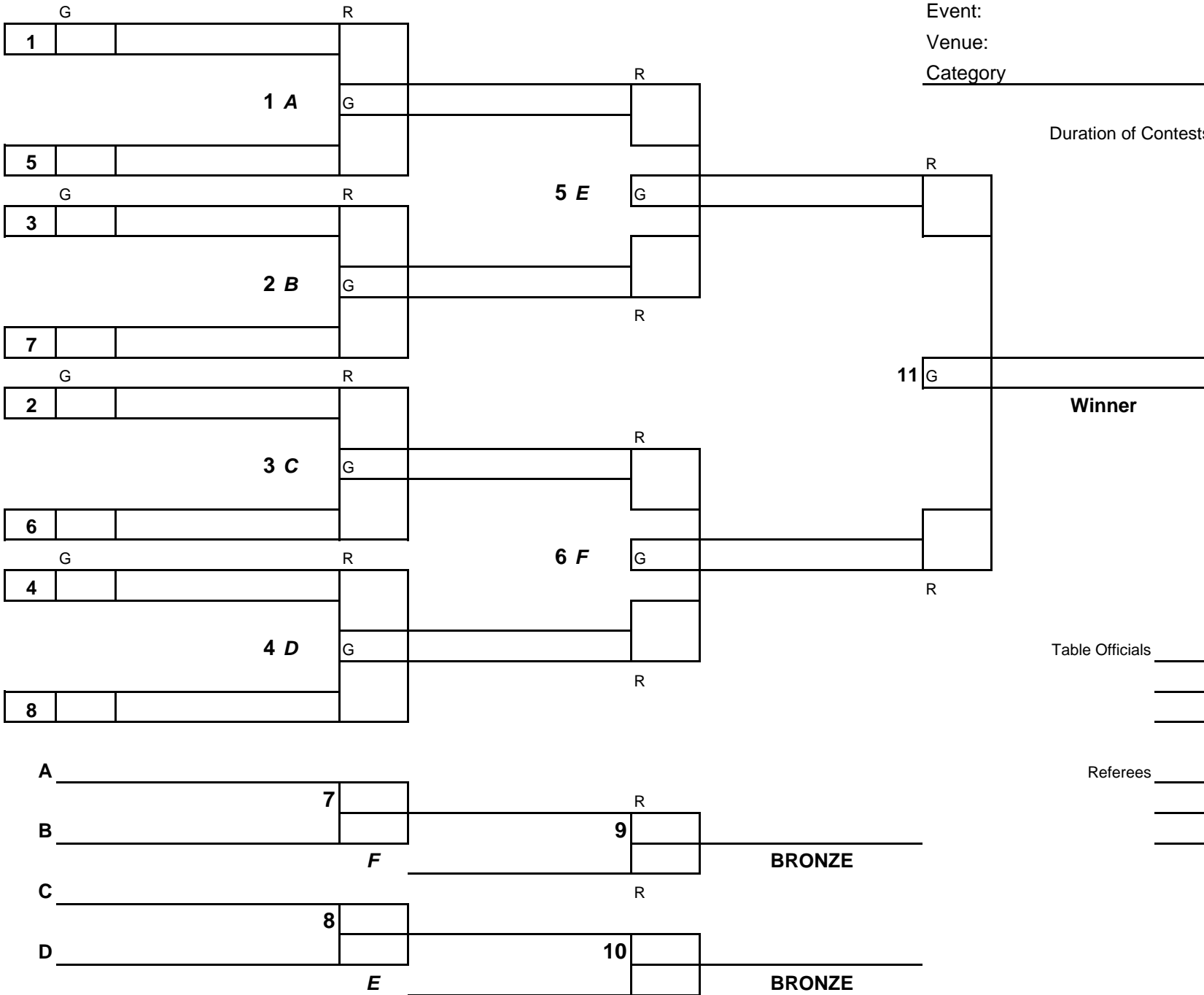

Table Officials _____

Referees _____

Double Knockout for 9 to 16 Players

Date: _____
 Event: _____
 Venue: _____
 Category: _____

Duration of Contests _____ Minutes

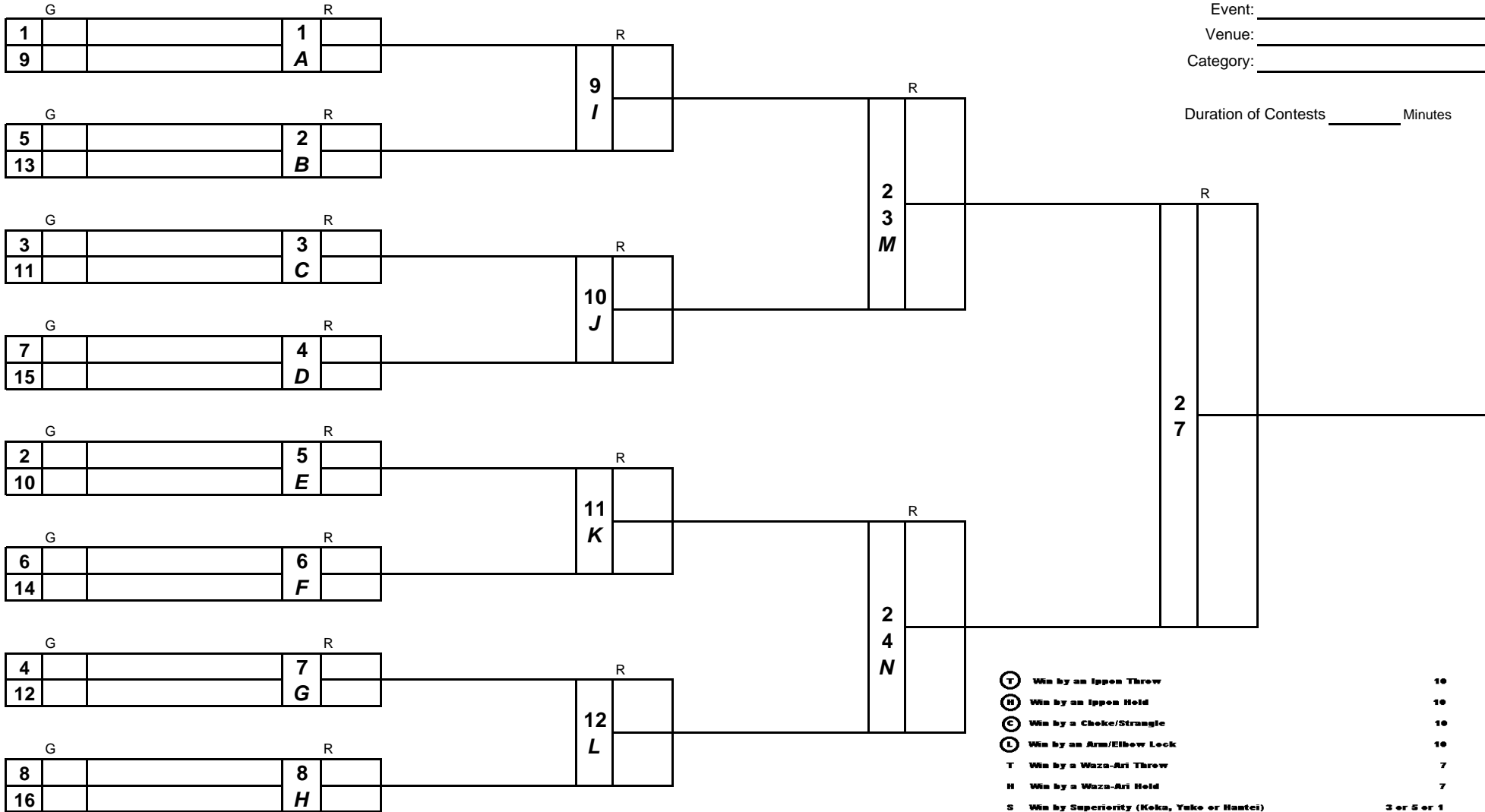

Referees _____

Table Officials _____

- T** Win by an Ippen Throw 10
- H** Win by an Ippen Hold 10
- C** Win by a Choke/Strangle 10
- L** Win by an Arm/Elbow Lock 10
- T** Win by a Waza-Ari Throw 7
- H** Win by a Waza-Ari Hold 7
- S** Win by Superiority (Koka, Yuko or Hantei) 3 or 5 or 1
- FG** Win by Fusen-Gachi (Non-appearance of opponent) 0
- KC** Win by a Kiken-Gachi (Withdrawal of opponent due to injury) 10
- SG** Win by Sege-Gachi (Compound Win) 10
- HM** Win by Hansoku-Make (Direct) 10
- △** Win by Hansoku-Make (Accumulated) 10
- △** Win by a Penalty (Shido, Chui, Keikoku Against Opponent) 7 or 5 or 3
- D** Brawa Contest 0
- I** Less of Contest 0

Double Knockout for 9 to 16 Players

Date: _____
 Event: _____
 Venue: _____
 Category: _____

Duration of Contests _____ Minutes

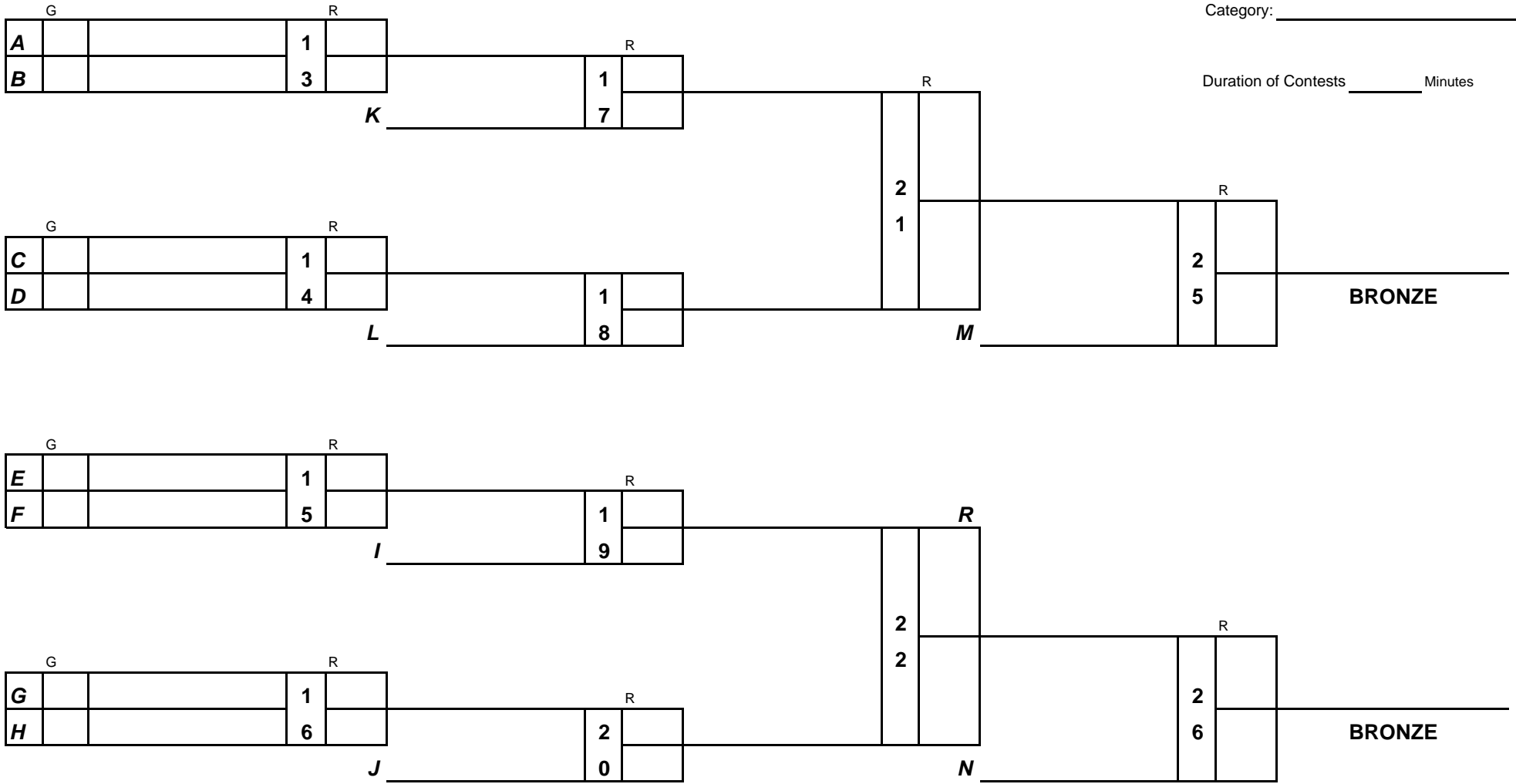

Referees _____

Table Officials _____

Double Knockout for 17 to 32 Players SECTION A

Date: _____
 Event: _____
 Venue: _____
 Category: _____

Duration of Contests _____ Minutes

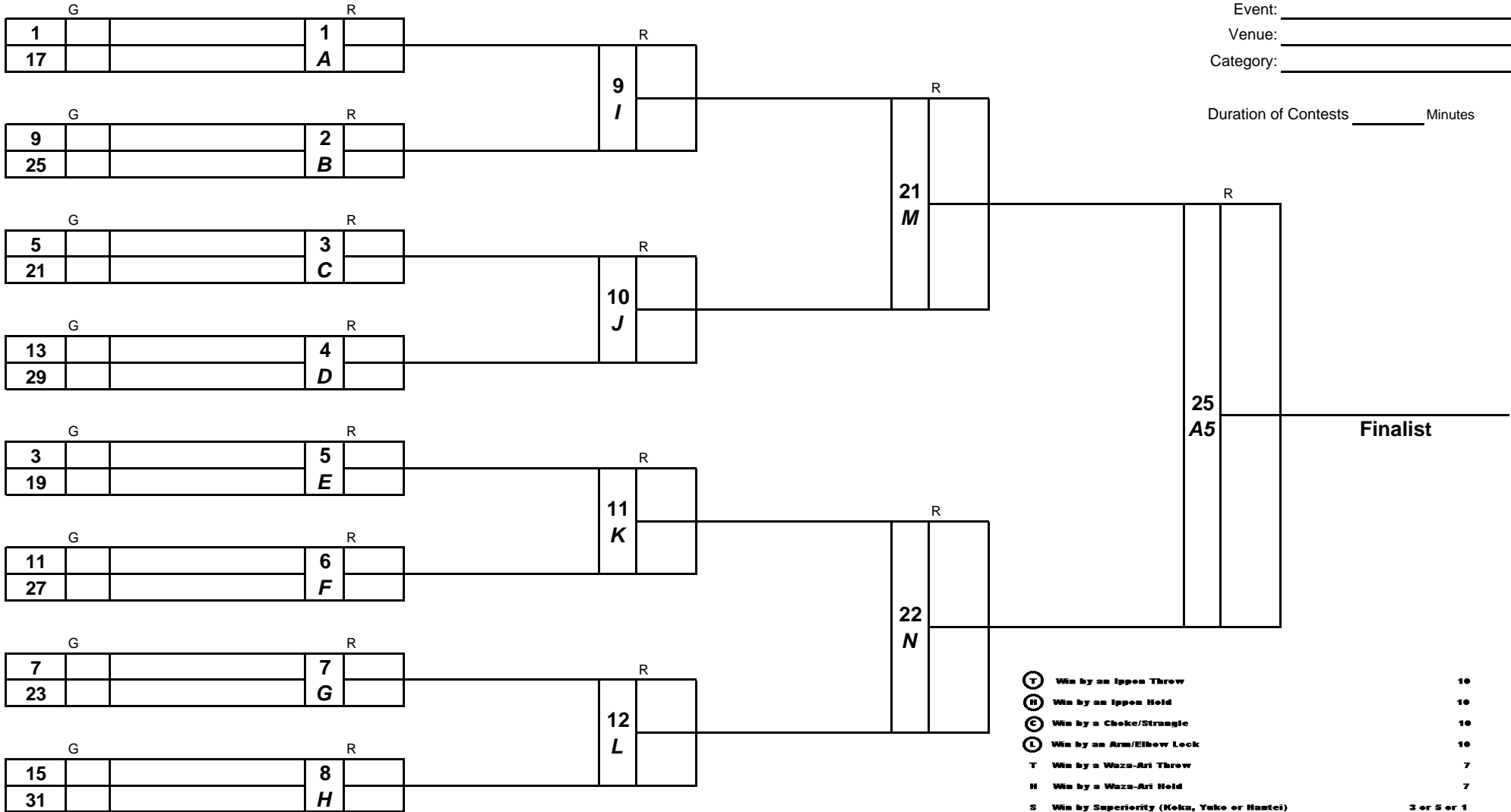

Referees _____

Table Officials _____

- Ⓣ Win by an Ippen Throw 10
- Ⓜ Win by an Ippen Hold 10
- Ⓢ Win by a Choke/Strangle 10
- Ⓛ Win by an Arm/Elbow Lock 10
- T Win by a Waza-Ari Throw 7
- H Win by a Waza-Ari Hold 7
- S Win by Superiority (Koka, Yoko or Hantei) 3 or 5 or 1
- FG Win by Fusen-Gachi (Non-appearance of opponent) 0
- KG Win by a Kiken-Gachi (Withdrawal of opponent due to injury) 10
- SG Win by Sege-Gachi (Compound Win) 10
- HM Win by Hansoku-Make (Direct) 10
- △ Win by Hansoku-Make (Accumulated) 10
- △ Win by a Penalty (Shido, Chui, Keikoku Against Opponent) 7 or 5 or 3
- D Drawn Contest 0
- L Loss of Contest 0

Double Knockout for 17 to 32 Players Section A Repechage First Section

Date: _____
 Event: _____
 Venue: _____
 Category: _____

Duration of Contests _____ Minutes

A	G			1	R
B				3	

K

				1	R
				7	

R

				2	R
				3	

A1

C	G			1	R
D				4	

L

				1	R
				8	

M

A2

E	G			1	R
F				5	

I

				1	R
				9	

R

				2	R
				4	

A3

G	G			1	R
H				6	

J

				2	R
				0	

N

A4

Referees _____

Table Officials _____

Double Knockout for 17 to 32 Players SECTION B

Date: _____
 Event: _____
 Venue: _____
 Category: _____

Duration of Contests _____ Minutes

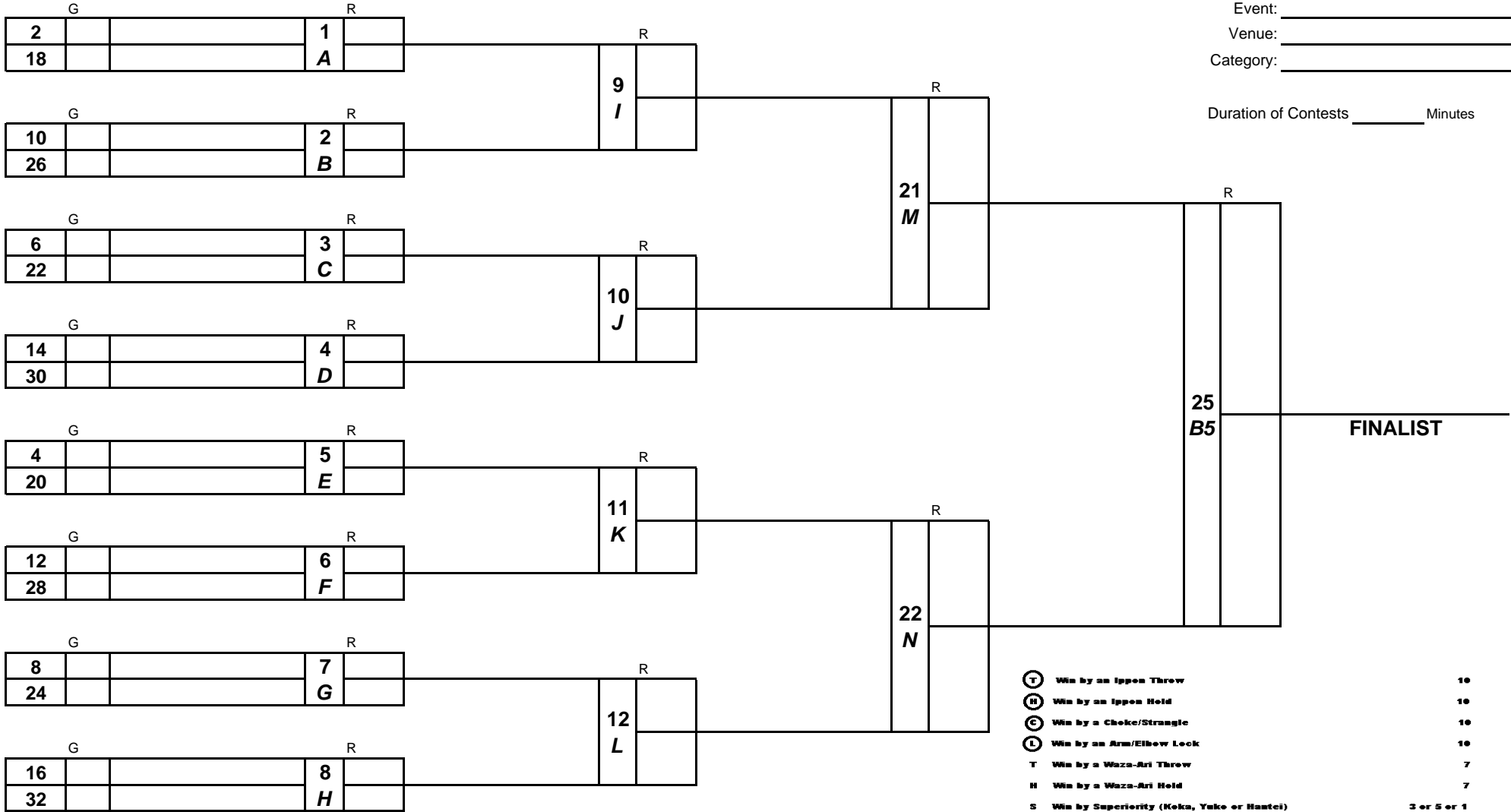

Referees _____

Table Officials _____

- (T)** Win by an Ippen Throw 10
- (H)** Win by an Ippen Hold 10
- (C)** Win by a Choke/Strangle 10
- (L)** Win by an Arm/Elbow Lock 10
- T** Win by a Waza-Ari Throw 7
- H** Win by a Waza-Ari Hold 7
- S** Win by Superiority (Koka, Yuko or Hantei) 3 or 5 or 1
- FG** Win by Fusen-Gachi (Non-appearance of opponent) 0
- KG** Win by a Kiken-Gachi (Withdrawal of opponent due to injury) 10
- SG** Win by Sego-Gachi (Compound Win) 10
- HM** Win by Hansoku-Make (Direct) 10
- (△)** Win by Hansoku-Make (Accumulated) 10
- (△)** Win by a Penalty (Shido, Chui, Keikoku Against Opponent) 7 or 5 or 3
- D** Drawn Contest 0
- L** Loss of Contest 0

Double Knockout for 17 to 32 Players SECTION B Repechage First Section

Date: _____
 Event: _____
 Venue: _____
 Category: _____

Duration of Contests _____ Minutes

A	G			1	R
B				3	

K

				1	R
				7	

R

				2	R
				3	

B1

C	G			1	R
D				4	

L

				1	R
				8	

M

B2

E	G			1	R
F				5	

I

				1	R
				9	

R

				2	R
				4	

B3

G	G			1	R
H				6	

J

				2	R
				0	

N

B4

Referees _____

Table Officials _____

Double Knockout for 17 to 32 Players Repechage Second Section

Date: _____
 Event: _____
 Venue: _____
 Category: _____

Duration of Contests _____ Minutes

	G		R
A1			
B4			

	G		R
A3			
B2			

	G		R
A2			
B3			

	G		R
A4			
B1			

	R

	R

B5

BRONZE

	R

	R

A5

BRONZE

CATEGORY FINAL

	G		R
A			
B			

Referees _____

Table Officials _____

- T** Win by an Ippon Throw 10
- R** Win by an Ippon Hold 10
- C** Win by a Choke/Strangle 10
- L** Win by an Arm/Elbow Lock 10
- T** Win by a Waza-Ari Throw 7
- H** Win by a Waza-Ari Hold 7
- S** Win by Superiority (Kokoa, Yaku or Maebito) 3 or 5 or 1
- FC** Win by Face-Guchi (Non-appearance of opponent) 0
- WC** Win by a Kikou-Guchi (Withdrawal of opponent due to injury) 10
- SC** Win by Sage-Guchi (Composed Win) 10
- HM** Win by Hansoku-Make (Direct) 10
- ▲** Win by Hansoku-Make (Accumulated) 10
- ▲** Win by a Penalty (Ukida, Chui, Keiboku Against Opponent) 7 or 5 or 3
- D** Brown Contest 0
- L** Loss of Contest 0

Double Knockout for 33 to 64 Players SECTION A

Date: _____

Event: _____

Venue: _____

Category: _____

Duration of Contests _____ Minutes

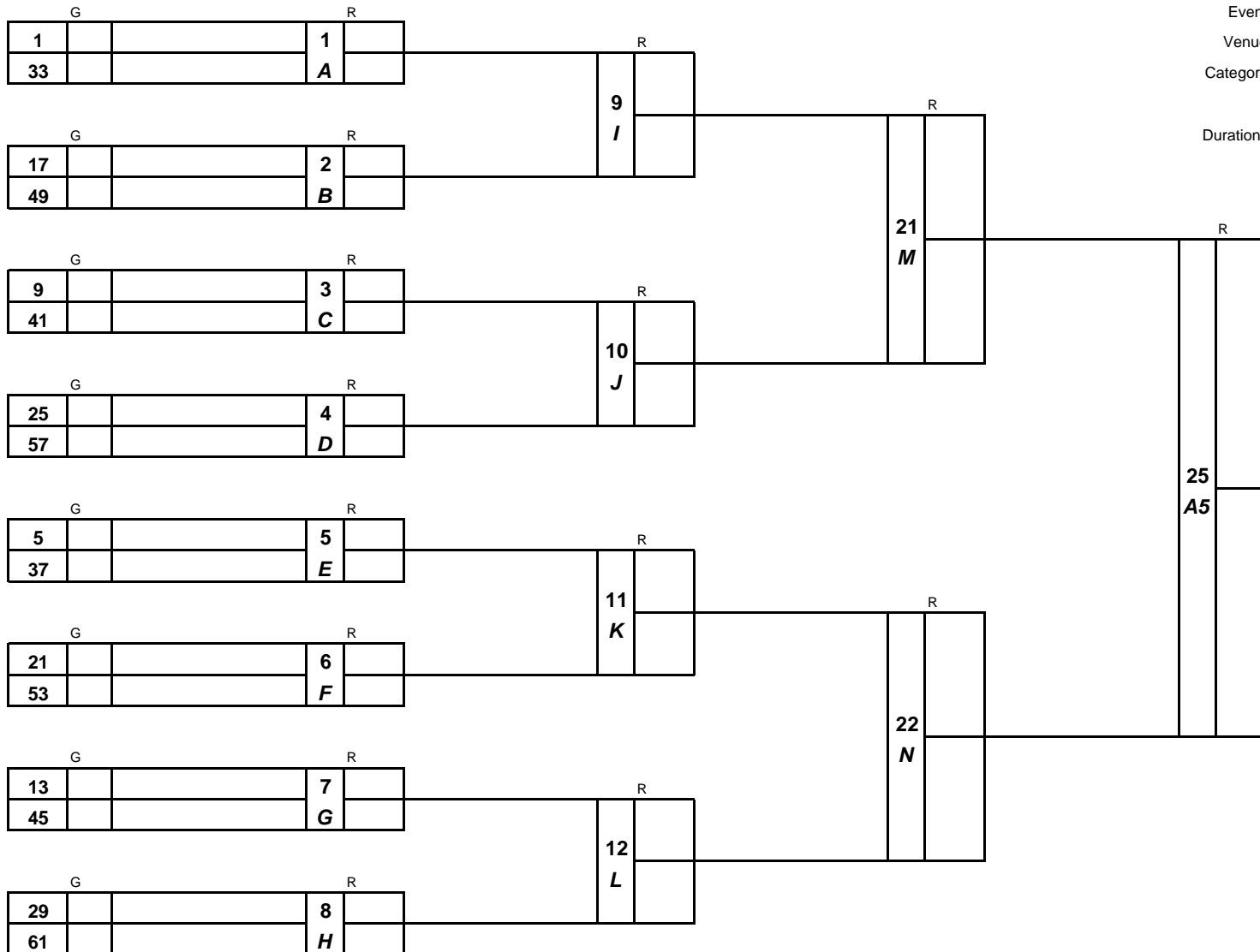

- T** Win by an Ippon Throw 10
- H** Win by an Ippon Hold 10
- C** Win by a Choke/Strangle 10
- L** Win by an Arm/Elbow Lock 10
- T** Win by a Waza-Ari Throw 7
- H** Win by a Waza-Ari Hold 7
- S** Win by Superiority (Keku, Yuko or Hantei) 3 or 5 or 1
- FG** Win by Fusen-Gachi (Non-appearance of opponent) 0
- KG** Win by a Miken-Gachi (Withdrawal of opponent due to injury) 10
- SG** Win by Segoe-Gachi (Compound Win) 10
- HM** Win by Hansoku-Make (Direct) 10
- Δ** Win by Hansoku-Make (Accumulated) 10
- Δ** Win by a Penalty (Shido, Chui, Keikoku Against Opponent) 7 or 5 or 3
- D** Drawn Contest 0
- L** Loss of Contest 0

Referees _____

Table Officials _____

Double Knockout for 33 to 64 Players Section A Repechage First Section

Date: _____
 Event: _____
 Venue: _____
 Category: _____

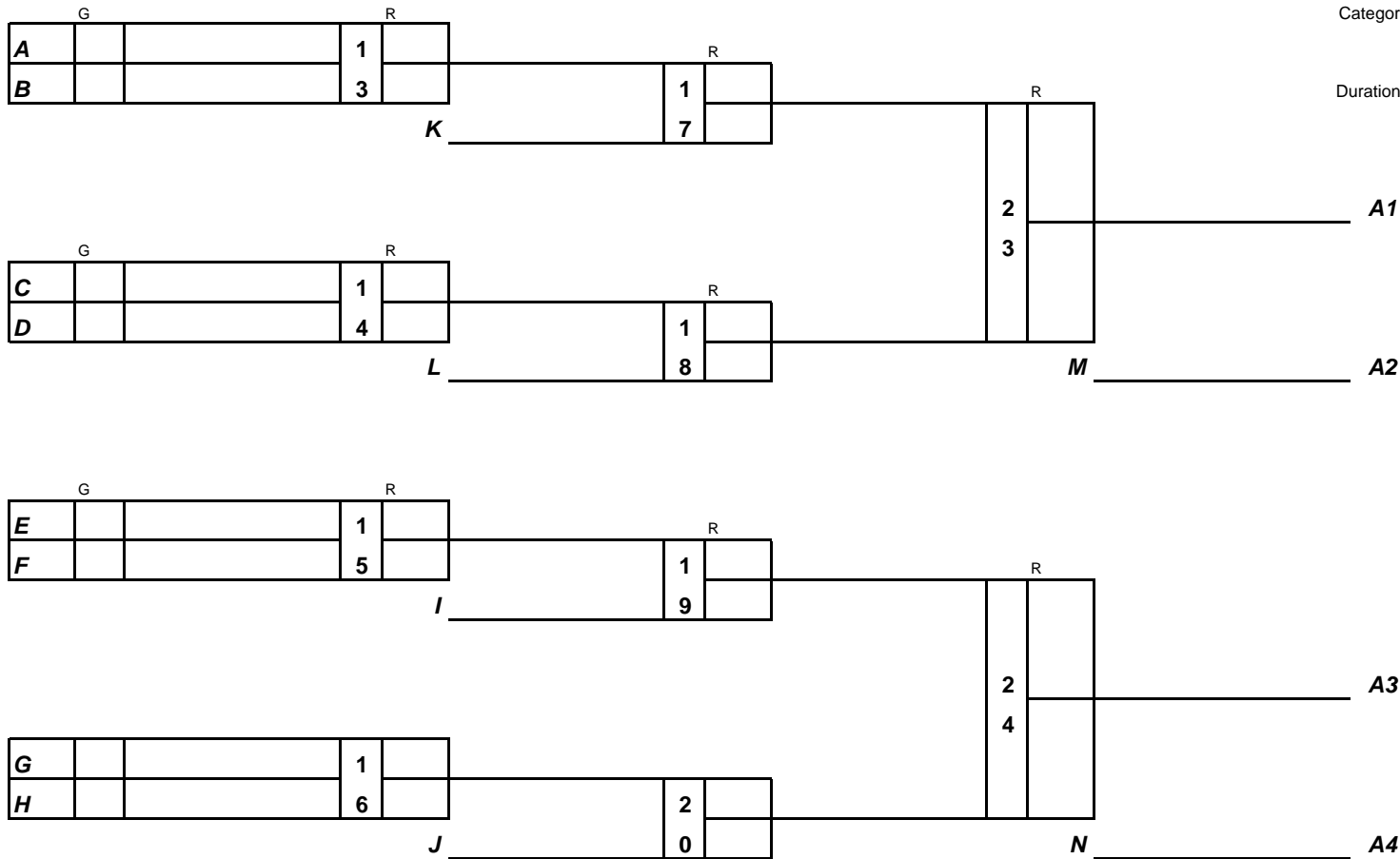

Duration of Contests _____ Minutes

- (T)** Win by an Ippon Throw 10
- (H)** Win by an Ippon Hold 10
- (C)** Win by a Choke/Strangle 10
- (L)** Win by an Arm/Elbow Lock 10
- T** Win by a Waza-Ari Throw 7
- H** Win by a Waza-Ari Hold 7
- S** Win by Superiority (Koka, Yuko or Hantei) 3 or 5 or 1
- FG** Win by Fusen-Gachi (Non-appearance of opponent) 0
- KG** Win by a Kiken-Gachi (Withdrawal of opponent due to injury) 10
- SG** Win by Segu-Gachi (Compound Win) 10
- HM** Win by Hansoku-Make (Direct) 10
- △** Win by Hansoku-Make (Accumulated) 10
- △** Win by a Penalty (Shido, Chui, Keikoku Against Opponent) 7 or 5 or 3
- D** Drawn Contest 0
- L** Loss of Contest 0

Referees _____

Table Officials _____

Double Knockout for 33 to 64 Players SECTION B

Date: _____

Event: _____

Venue: _____

Category: _____

Duration of Contests _____ Minutes

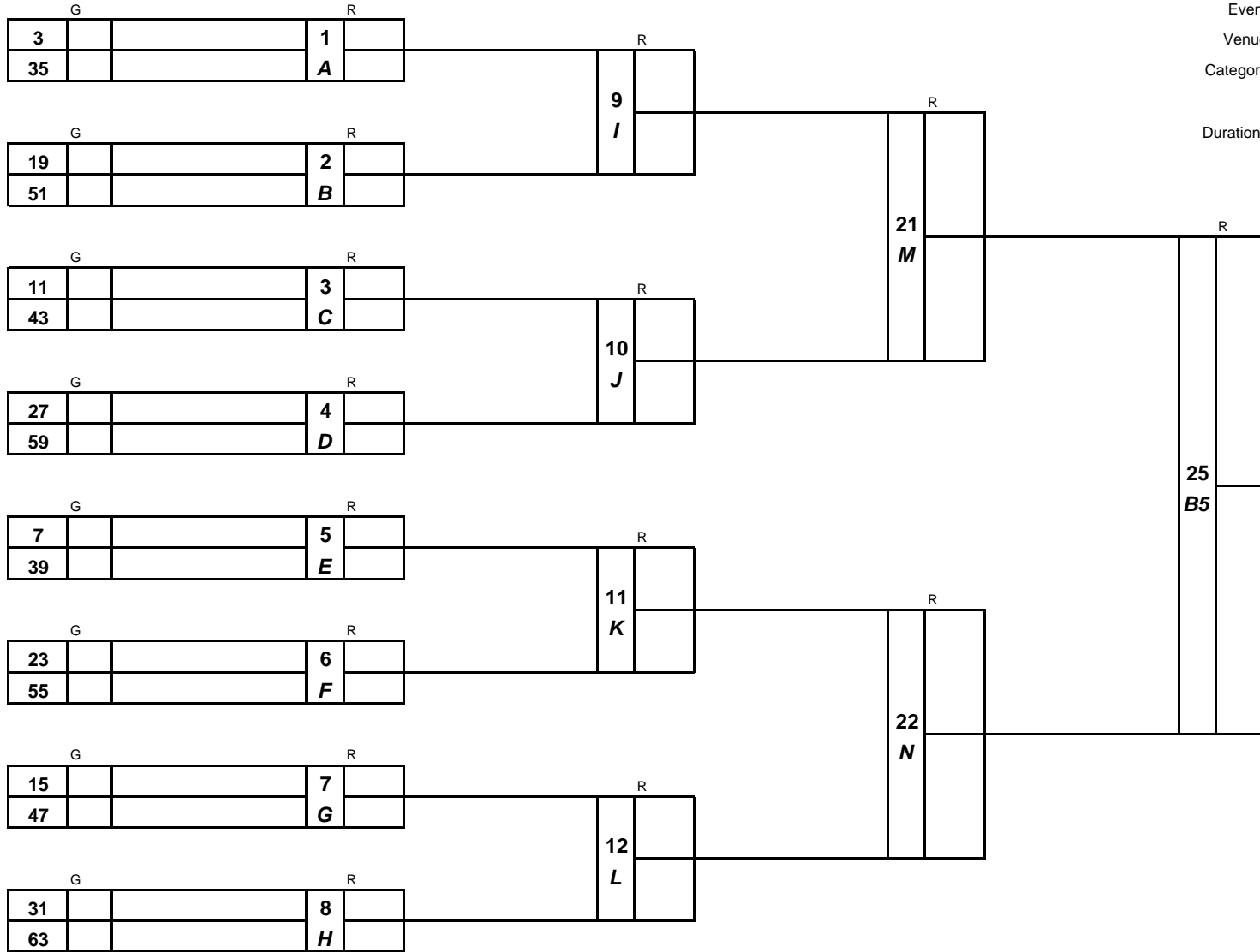

SEMI-FINALIST

- (T)** Win by an Ippon Throw 10
- (H)** Win by an Ippon Hold 10
- (C)** Win by a Choke/Strangle 10
- (L)** Win by an Arm/Elbow Lock 10
- T** Win by a Waza-Ari Throw 7
- H** Win by a Waza-Ari Hold 7
- S** Win by Superiority (Koka, Yuko or Hautei) 3 or 5 or 1
- FG** Win by Fusen-Gachi (Non-appearance of opponent) 0
- KG** Win by a Kiken-Gachi (Withdrawal of opponent due to injury) 10
- SG** Win by Sego-Gachi (Compound Win) 10
- NM** Win by Hansoku-Make (Direct) 10
- △** Win by Hansoku-Make (Accumulated) 10
- △** Win by a Penalty (Shido, Chui, Keikoku Against Opponent) 7 or 5 or 3
- D** Drawn Contest 0
- L** Less of Contest 0

Referees _____

Table Officials _____

Double Knockout for 33 to 64 Players SECTION B Repechage First Section

Date: _____
 Event: _____
 Venue: _____
 Category: _____

Duration of Contests _____ Minutes

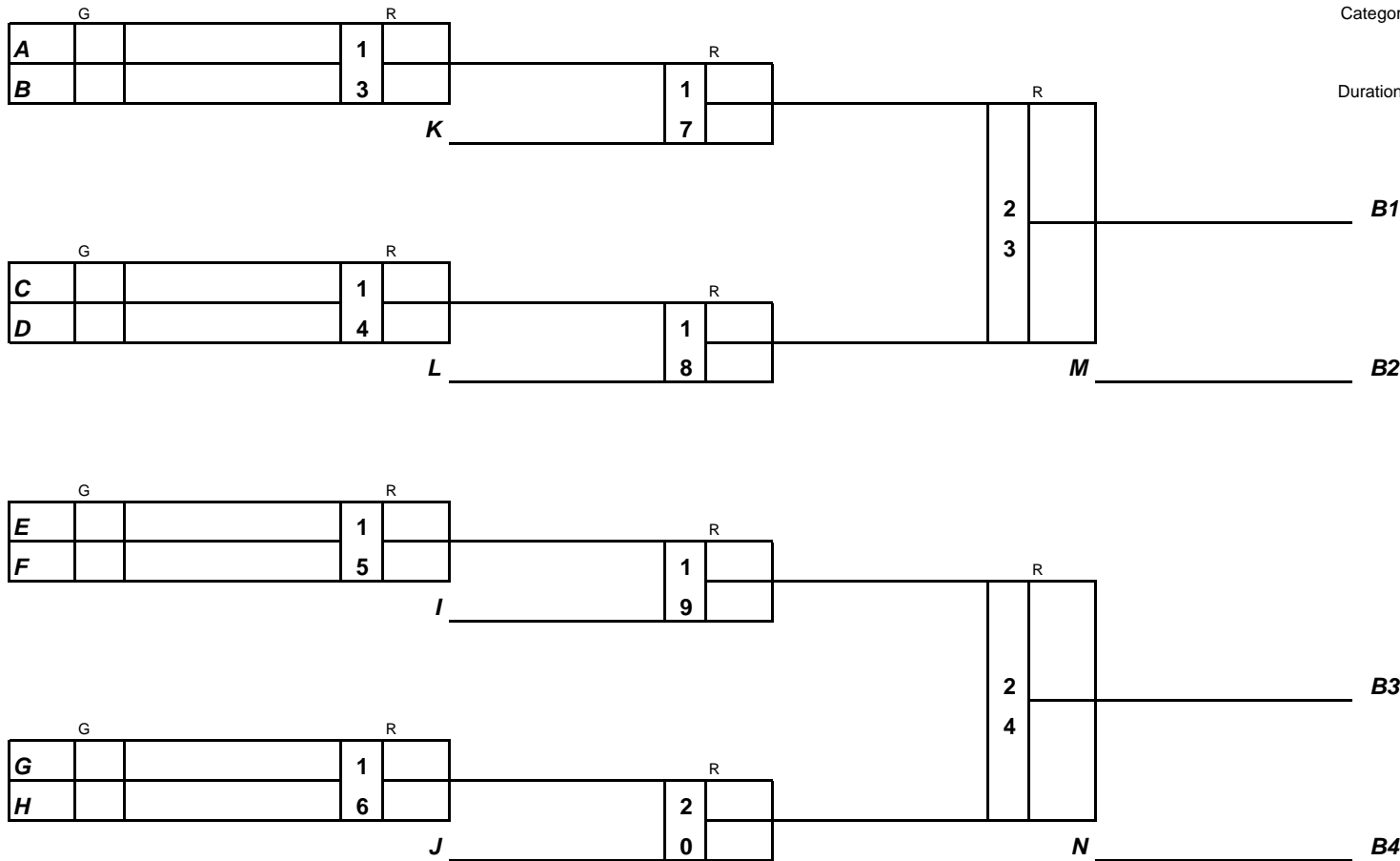

- T** Win by an Ippon Throw 10
- H** Win by an Ippon Hold 10
- C** Win by a Choke/Strangle 10
- L** Win by an Arm/Elbow Lock 10
- T** Win by a Waza-Ari Throw 7
- H** Win by a Waza-Ari Hold 7
- S** Win by Superiority (Koka, Yuko or Hantei) 3 or 5 or 1
- FG** Win by Fusen-Gachi (Non-appearance of opponent) 0
- KG** Win by a Kiken-Gachi (Withdrawal of opponent due to injury) 10
- SG** Win by Sego-Gachi (Compound Win) 10
- HM** Win by Hansoku-Make (Direct) 10
- Δ** Win by Hansoku-Make (Accumulated) 10
- Δ** Win by a Penalty (Shido, Chui, Keikoku Against Opponent) 7 or 5 or 3
- D** Drawn Contest 0
- L** Less of Contest 0

Referees _____

Table Officials _____

Double Knockout for 33 to 64 Players SECTION C

Date: _____

Event: _____

Venue: _____

Category: _____

Duration of Contests _____ Minutes

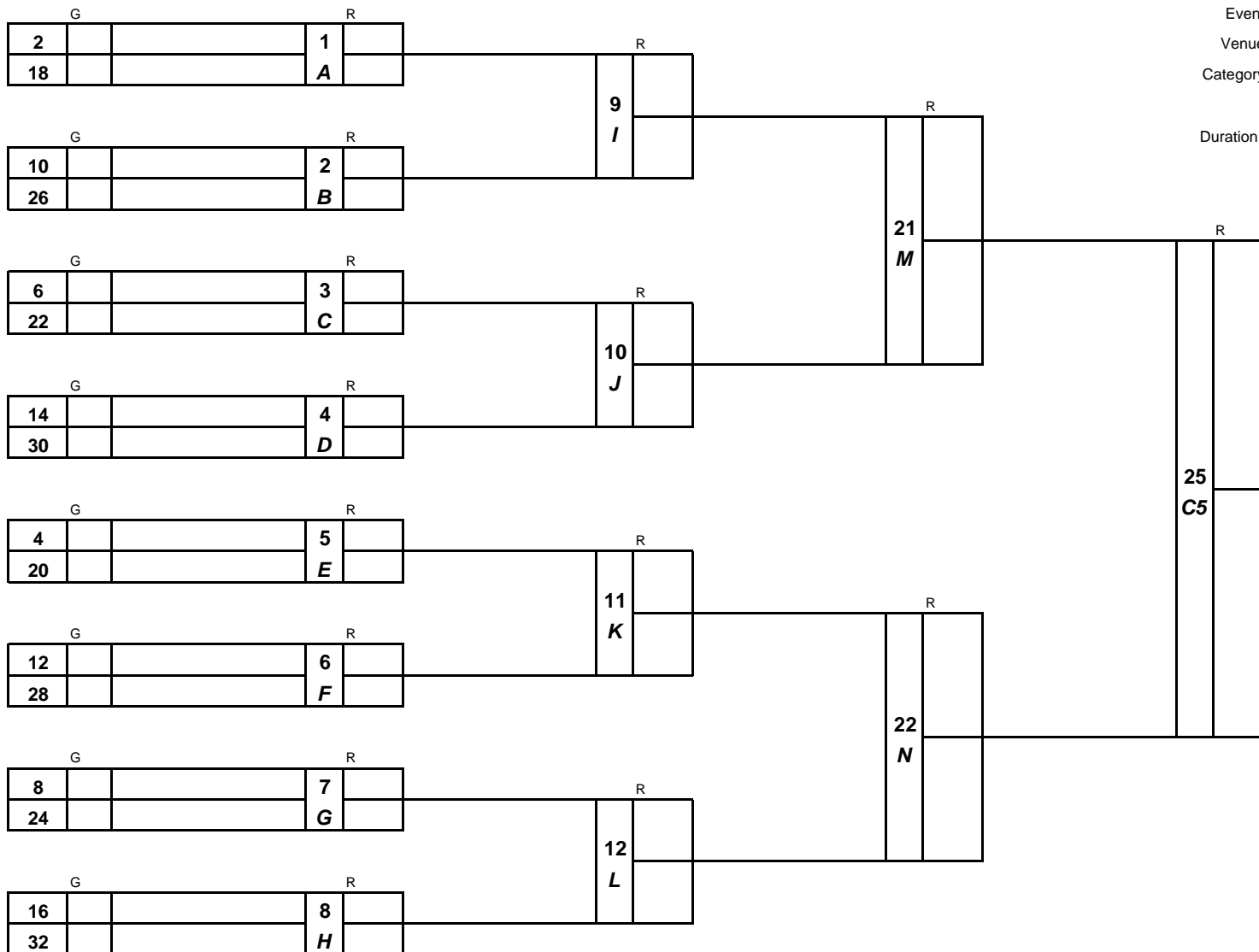

SEMI-FINALIST

- (T)** Win by an Ippon Throw 10
- (H)** Win by an Ippon Hold 10
- (C)** Win by a Choke/Strangle 10
- (L)** Win by an Arm/Elbow Lock 10
- T** Win by a Waza-Ari Throw 7
- H** Win by a Waza-Ari Hold 7
- S** Win by Superiority (Koka, Yuko or Hantei) 3 or 5 or 1
- FG** Win by Fusen-Gachi (Non-appearance of opponent) 0
- KG** Win by a Kiken-Gachi (Withdrawal of opponent due to injury) 10
- SG** Win by Sogo-Gachi (Compound Win) 10
- HM** Win by Hansoku-Make (Direct) 10
- △** Win by Hansoku-Make (Accumulated) 10
- ▲** Win by a Penalty (Shido, Chui, Keikoku Against Opponent) 7 or 5 or 3
- D** Drawn Contest 0
- L** Loss of Contest 0

Referees _____

Table Officials _____

Double Knockout for 17 to 32 Players SECTION C Repechage First Section

Date: _____
 Event: _____
 Venue: _____
 Category: _____

Duration of Contests _____ Minutes

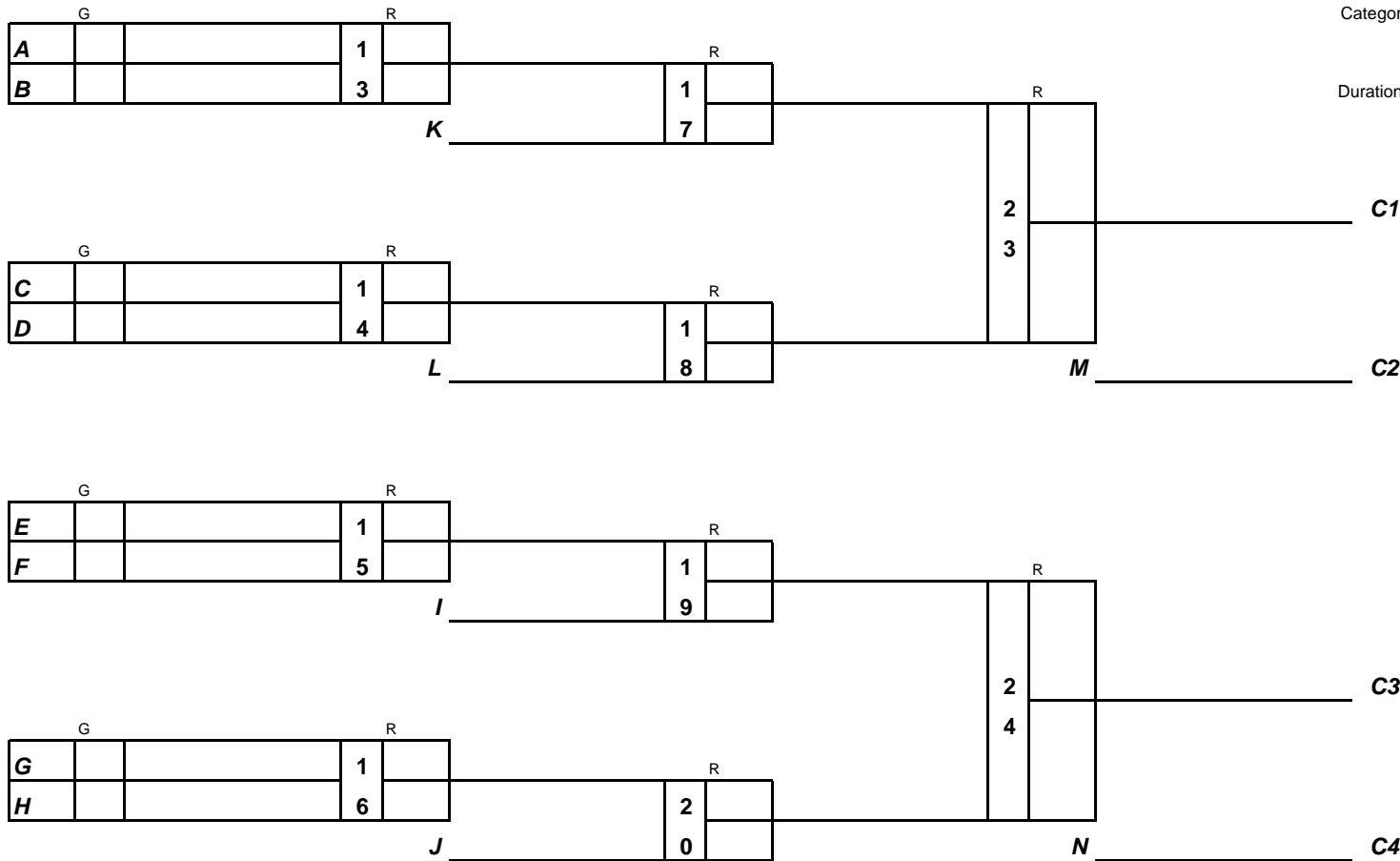

T	Win by an Ippon Throw	10
H	Win by an Ippon Hold	10
C	Win by a Choke/Strangle	10
L	Win by an Arm/Elbow Lock	10
T	Win by a Waza-Ari Throw	7
H	Win by a Waza-Ari Hold	7
S	Win by Superiority (Koka, Yuke or Hantei)	3 or 5 or 1
FG	Win by Fusen-Gachi (Non-appearance of opponent)	0
KG	Win by a Kiken-Gachi (Withdrawal of opponent due to injury)	10
SG	Win by Sege-Gachi (Compound Win)	10
HM	Win by Hansoku-Make (Direct)	10
△	Win by Hansoku-Make (Accumulated)	10
△	Win by a Penalty (Shido, Chui, Keikoku Against Opponent)	7 or 5 or 3
D	Drawn Contest	0
L	Loss of Contest	0

Referees _____

Table Officials _____

Double Knockout for 33 to 64 Players SECTION D

Date: _____

Event: _____

Venue: _____

Category: _____

Duration of Contests _____ Minutes

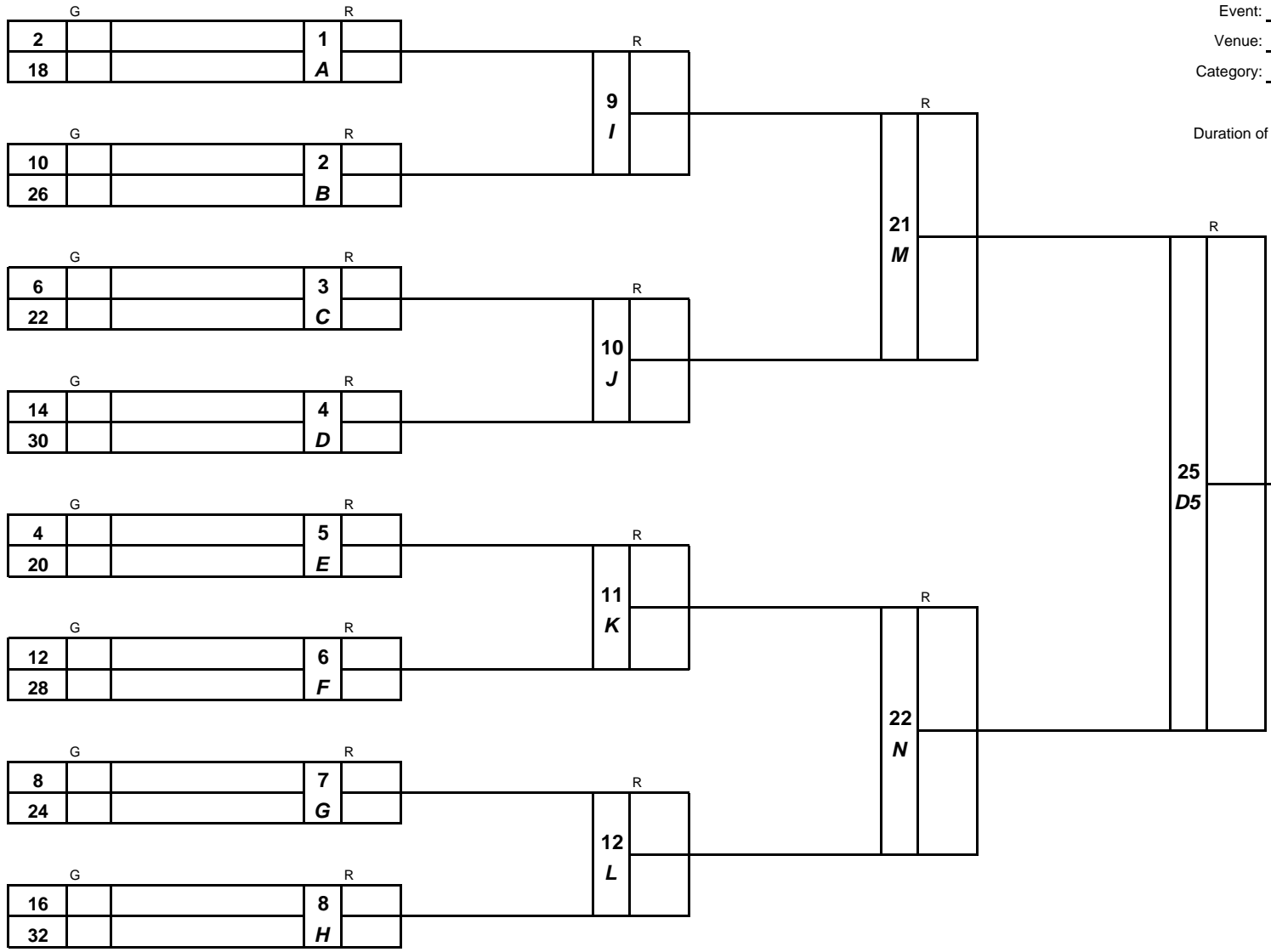

- Ⓣ Win by an Ippon Throw 10
- Ⓜ Win by an Ippon Hold 10
- Ⓒ Win by a Choke/Strangle 10
- Ⓛ Win by an Arm/Elbow Lock 10
- T Win by a Waza-Ari Throw 7
- H Win by a Waza-Ari Hold 7
- S Win by Superiority (Koka, Yako or Hantei) 3 or 5 or 1
- FG Win by Fusen-Gachi (Non-appearance of opponent) 0
- KG Win by a Kiken-Gachi (Withdrawal of opponent due to injury) 10
- SG Win by Sogo-Gachi (Compound Win) 10
- HM Win by Hansoku-Make (Direct) 10
- △ Win by Hansoku-Make (Accumulated) 10
- △ Win by a Penalty (Shido, Chui, Keikoku Against Opponent) 7 or 5 or 3
- D Drawn Contest 0
- L Loss of Contest 0

Referees _____

Table Officials _____

Double Knockout for 33 to 64 Players SECTION D Repechage First Section

Date: _____
 Event: _____
 Venue: _____
 Category: _____

Duration of Contests _____ Minutes

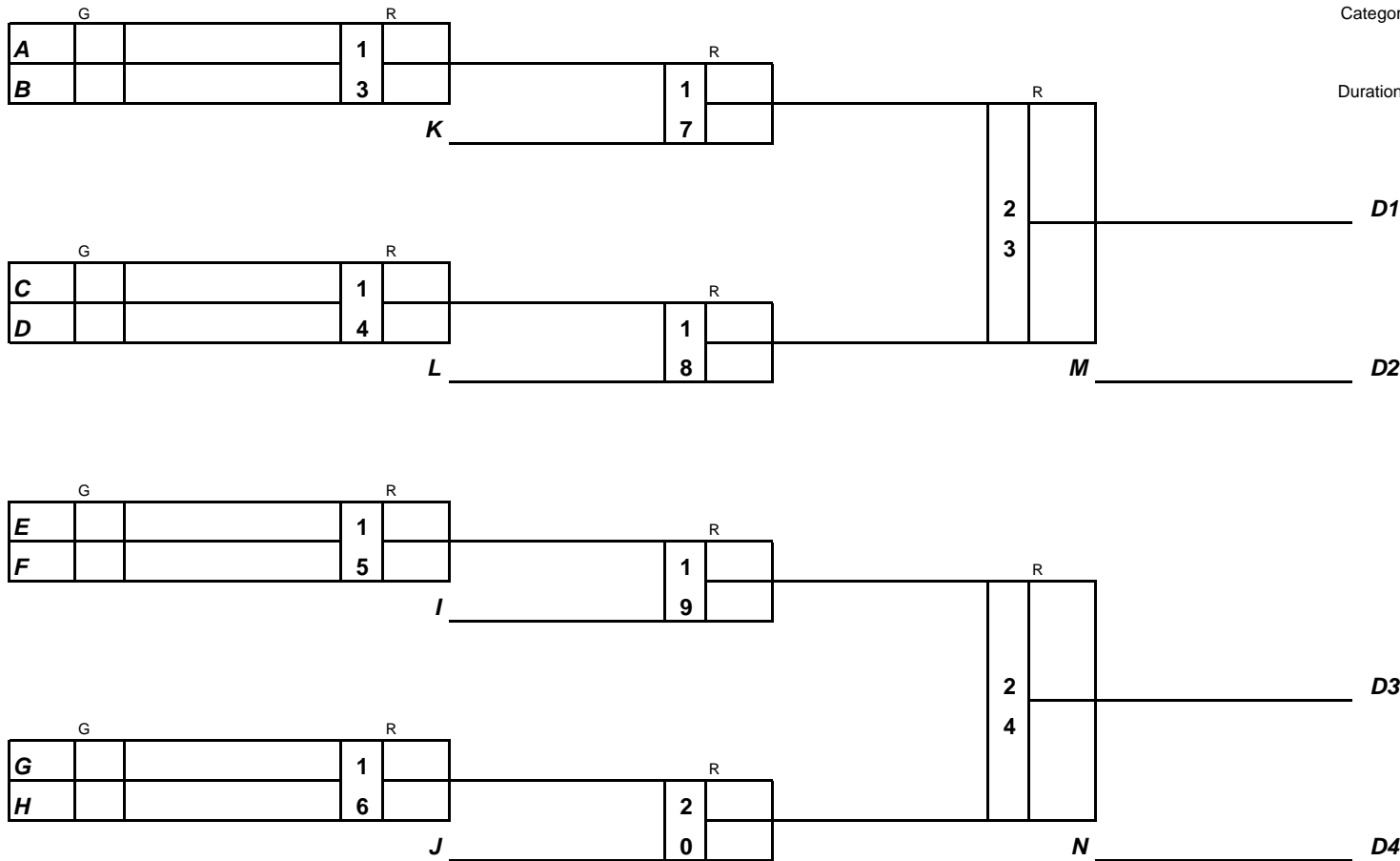

- Ⓣ Win by an Ippon Throw 10
- Ⓜ Win by an Ippon Hold 10
- Ⓢ Win by a Choke/Strangle 10
- Ⓛ Win by an Arm/Elbow Lock 10
- T Win by a Waza-Ari Throw 7
- H Win by a Waza-Ari Hold 7
- S Win by Superiority (Koka, Yuko or Hantei) 3 or 5 or 1
- FG Win by Fusen-Gachi (Non-appearance of opponent) 0
- KG Win by a Kiken-Gachi (Withdrawal of opponent due to injury) 10
- SG Win by Sege-Gachi (Compound Win) 10
- HM Win by Hansoku-Make (Direct) 10
- △ Win by Hansoku-Make (Accumulated) 10
- ⚠ Win by a Penalty (Shido, Chui, Keikoku Against Opponent) 7 or 5 or 3
- D Drawn Contest 0
- L Loss of Contest 0

Referees _____

Table Officials _____

Double Knockout for 33 to 64 Players Semi-Finals /Final and Repechage Second Section

Date: _____
 Event: _____
 Venue: _____
 Category: _____

Duration of Contests _____ Minutes

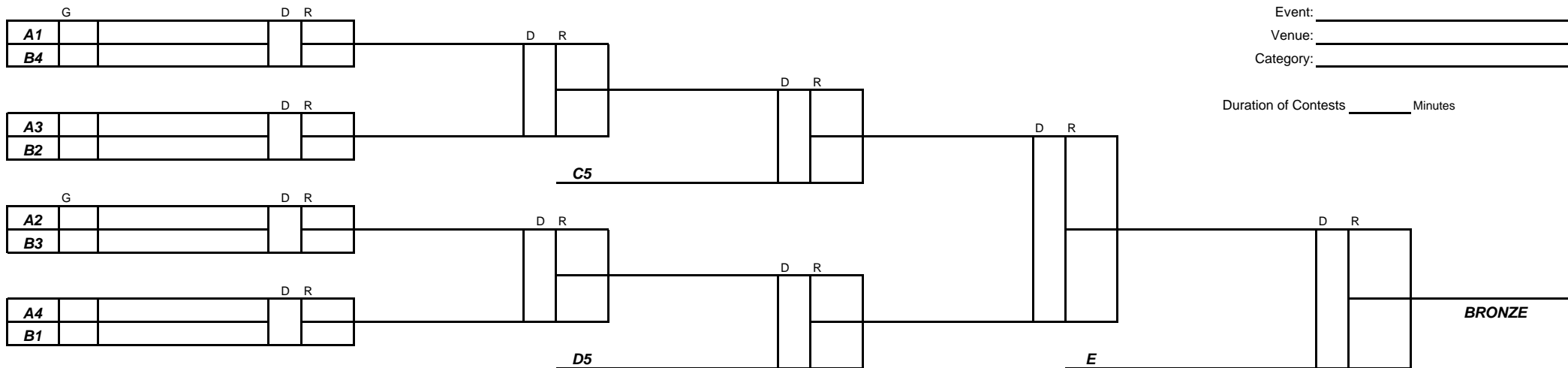

G= GRADE
R= RESULT
D= DURATION OF CONTEST

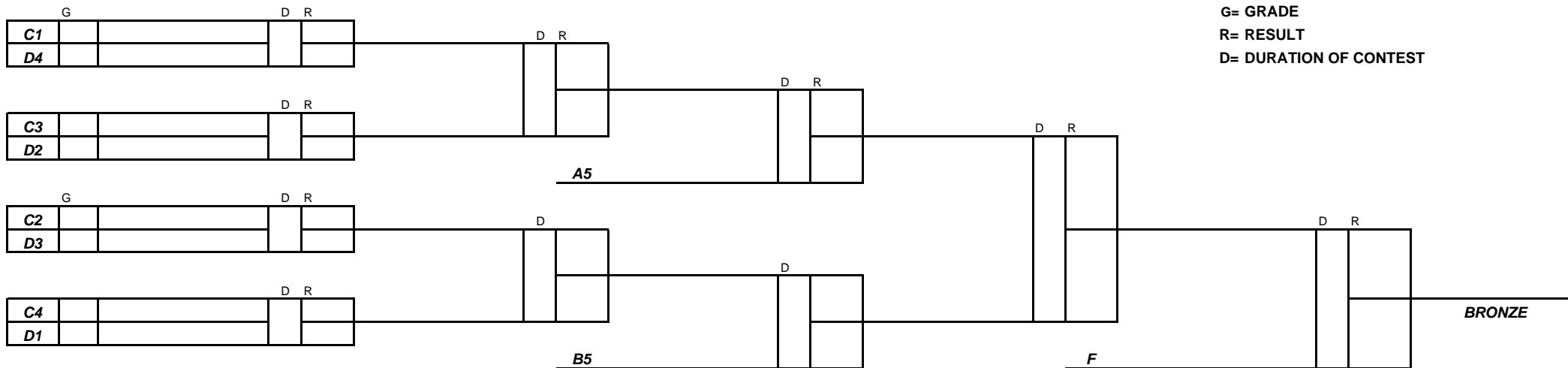

CATEGORY SEMI-FINAL AND FINAL

Referees _____

Table Officials _____

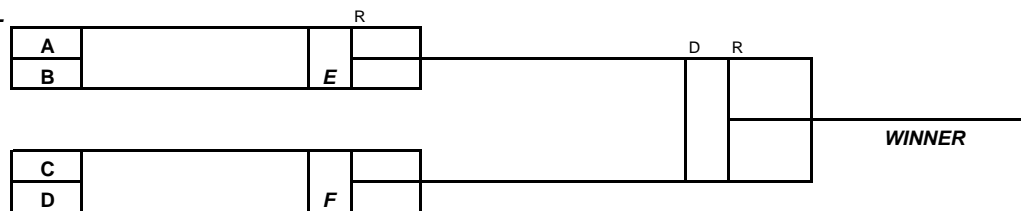

Knockout and Double Repechage Table for 5 to 8 Players

Date: _____

Event: _____

Venue: _____

Category: _____

Duration of Contests _____ Minutes

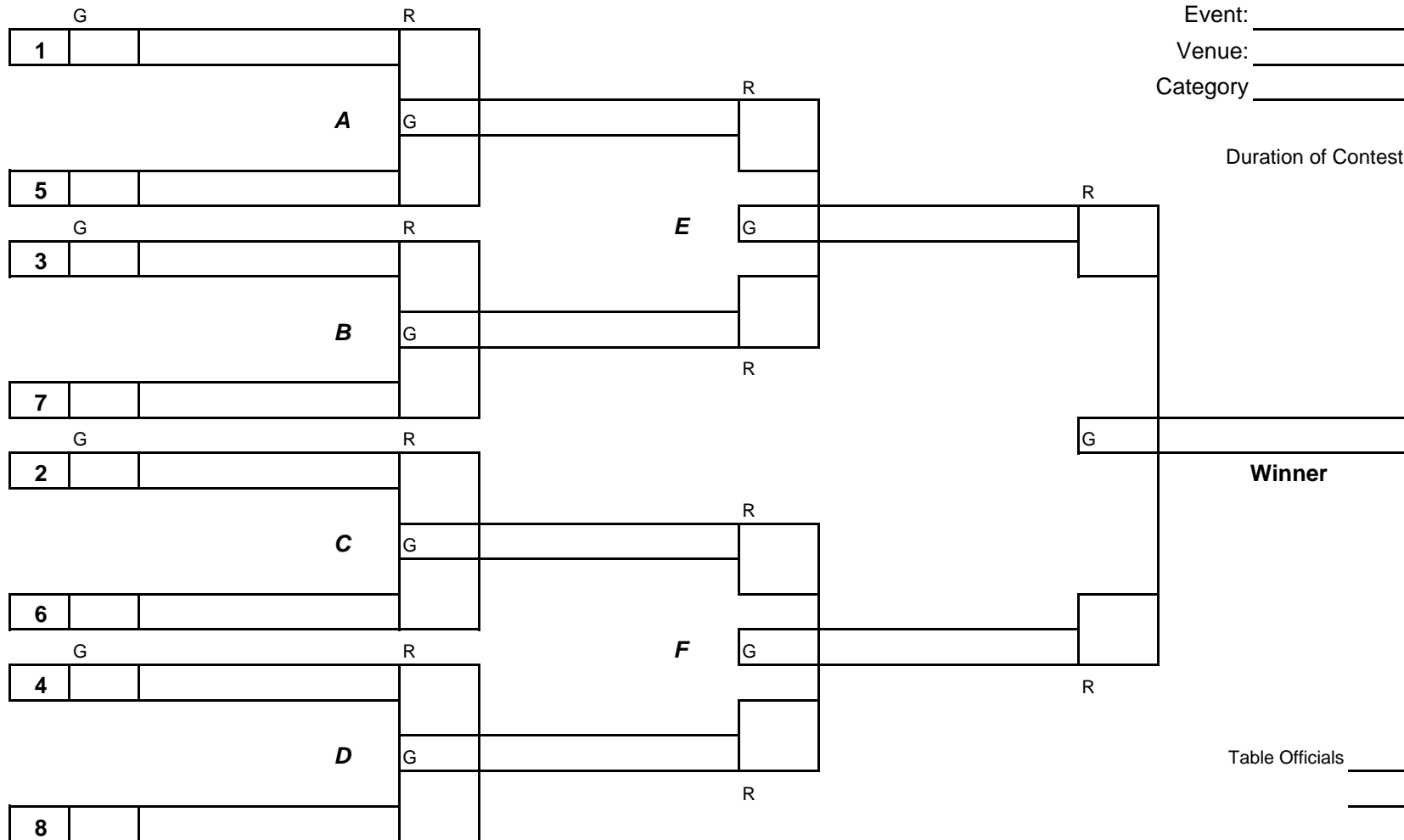

Table Officials _____

Referees _____

A _____

B _____

C _____

D _____

F

E

BRONZE

BRONZE

Knockout and Double Repechage Table for 9 to 16 Players

Date: _____

Event: _____

Venue: _____

Category: _____

Duration of Contests _____ Minutes

R

Section A

1					
9					
5					
13					

R

R

Section B

3					
11					
7					
15					

E

Section C

2					
10					
6					
14					

R

R

Section D

4					
12					
8					
16					

R

F

- Ⓣ Win by an Ippon Throw 10
- Ⓜ Win by an Ippon Hold 10
- Ⓒ Win by a Choke/Strangle 10
- Ⓛ Win by an Arm/Elbow Lock 10
- T Win by a Waza-Ari Throw 7
- H Win by a Waza-Ari Hold 7
- S Win by Superiority (Koka, Yuko or Hantei) 3 or 5 or 1
- FG Win by Fusen-Gachi (Non-appearance of opponent) 0
- KG Win by a Giken-Gachi (Withdrawal of opponent due to injury) 10
- SG Win by Sego-Gachi (Compound Win) 10
- HM Win by Hansoku-Make (Direct) 10
- ⚠ Win by Hansoku-Make (Accumulated) 10
- ⚠ Win by a Penalty (Shido, Chui, Keikoku Against Opponent) 7 or 5 or 3
- D Drawn Contest 0
- L Loss of Contest 0

Table Officials

_____ Referees _____

Repechage Section of Knockout and Double Repechage for 9 to 16 Players

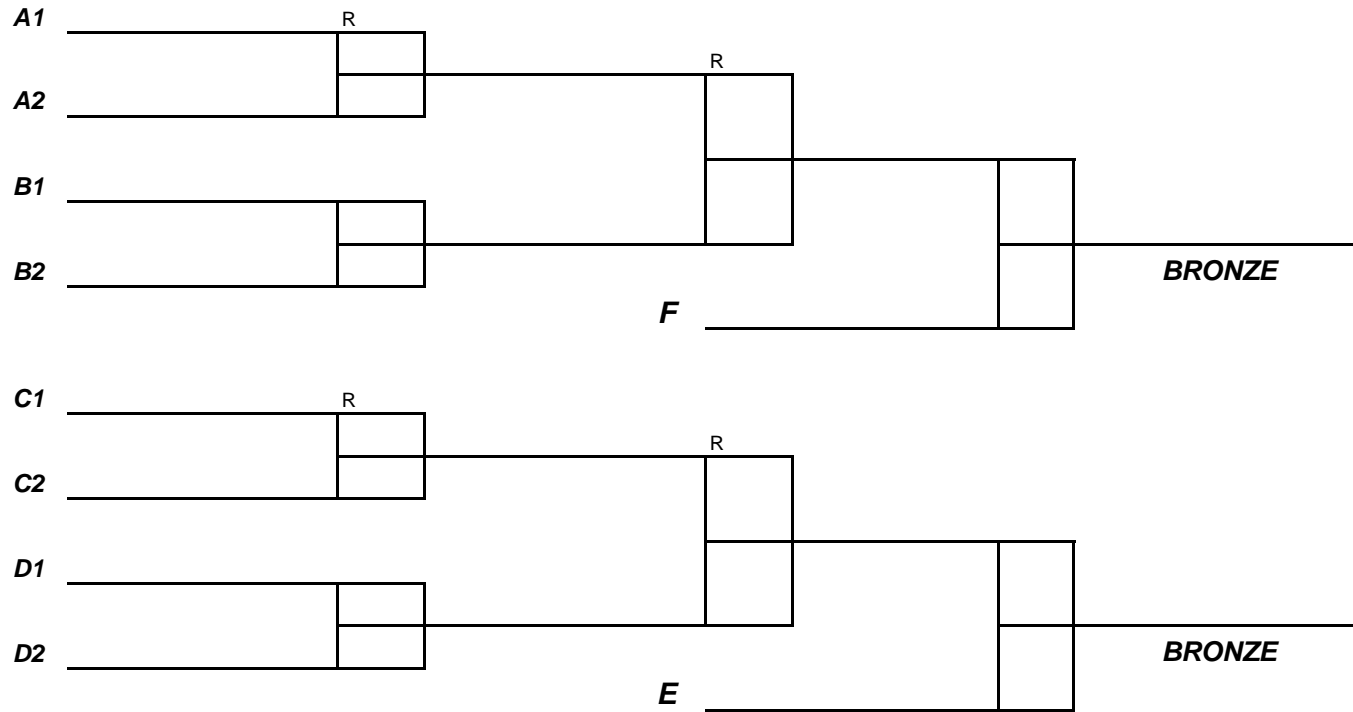

Table Officials _____

Referees _____

Date: _____

Event: _____

Venue: _____

Category: _____

Duration of Contests _____ Minutes

Ⓧ	Win by an Ippon Throw	10
Ⓜ	Win by an Ippon Hold	10
Ⓢ	Win by a Choke/Strangle	10
Ⓛ	Win by an Arm/Elbow Lock	10
T	Win by a Waza-Ari Throw	7
H	Win by a Waza-Ari Hold	7
S	Win by Superiority (Koka, Yako or Hantei)	3 or 5 or 1
FG	Win by Fusen-Gachi (Non-appearance of opponent)	0
KG	Win by a Kiken-Gachi (Withdrawal of opponent due to injury)	10
SG	Win by Soge-Gachi (Compound Win)	10
HM	Win by Hansoku-Make (Direct)	10
⚠	Win by Hansoku-Make (Accumulated)	10
⚠	Win by a Penalty (Shido, Chui, Keikoku Against Opponent)	7 or 5 or 3
D	Drawn Contest	0
L	Loss of Contest	0

Knockout and Double Repechage for 17 to 32 Players

Date: _____
 Event: _____
 Venue: _____
 Category: _____

Duration of Contests: _____ Minutes

SECTION A R

1		
17		
9		
25		
5		
21		
13		
29		

SECTION B R

3		
19		
11		
27		
7		
23		
15		
31		

SECTION C R

2		
18		
10		
26		
6		
22		
14		
30		

SECTION D R

4		
20		
12		
28		
8		
24		
16		
32		

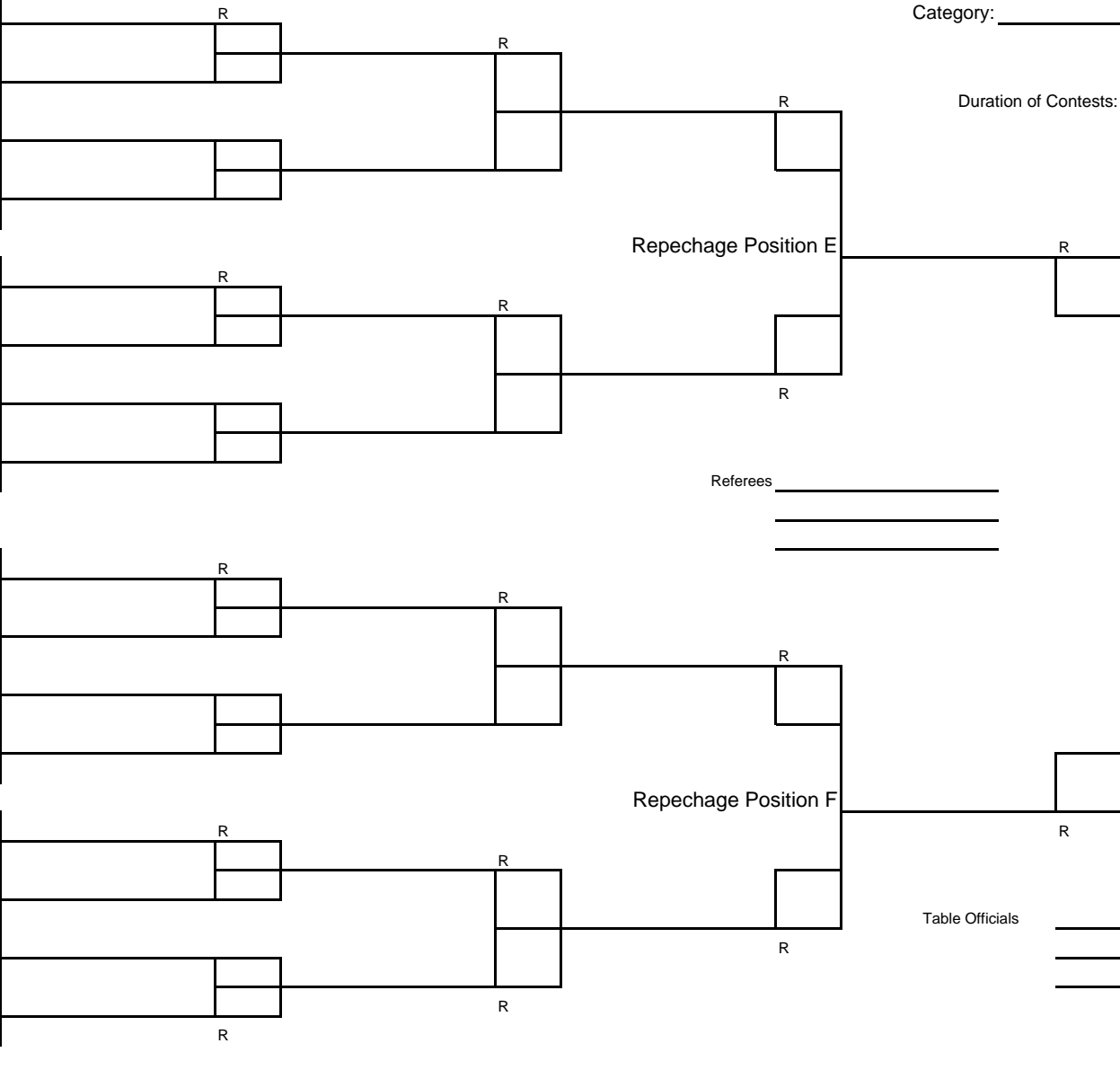

Referees _____

Table Officials _____

WINNER

Repechage Section of Knockout and Double Repechage for 17 to 32 Players

Date: _____
 Event: _____
 Venue: _____
 Category: _____

Duration of Contests: _____ Minutes

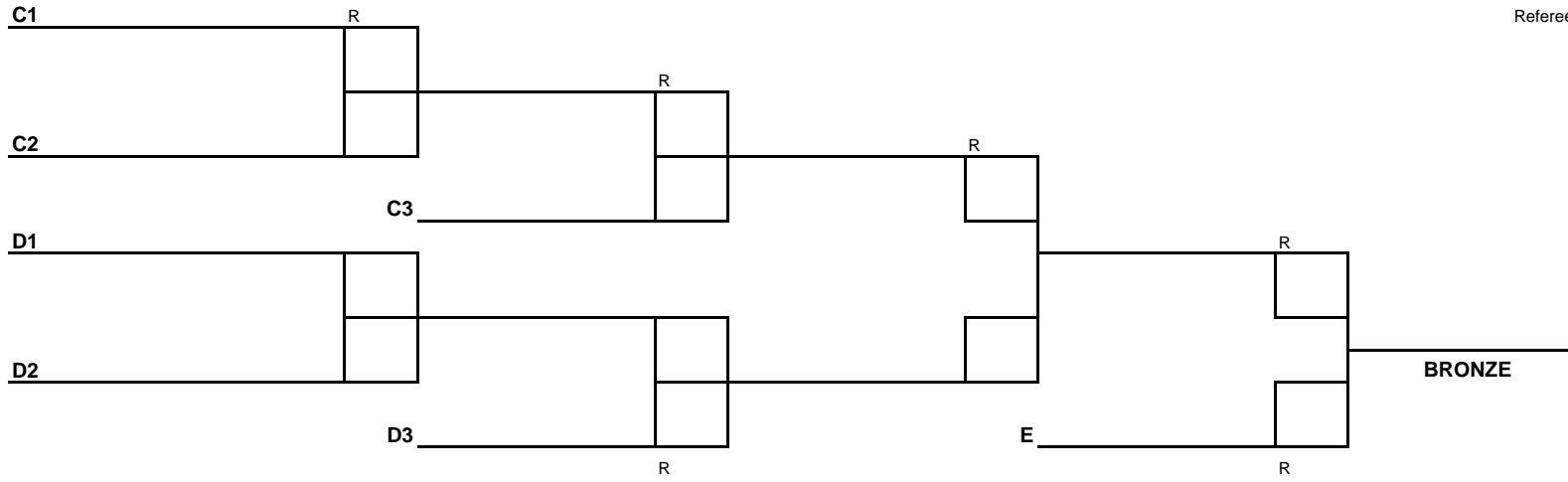
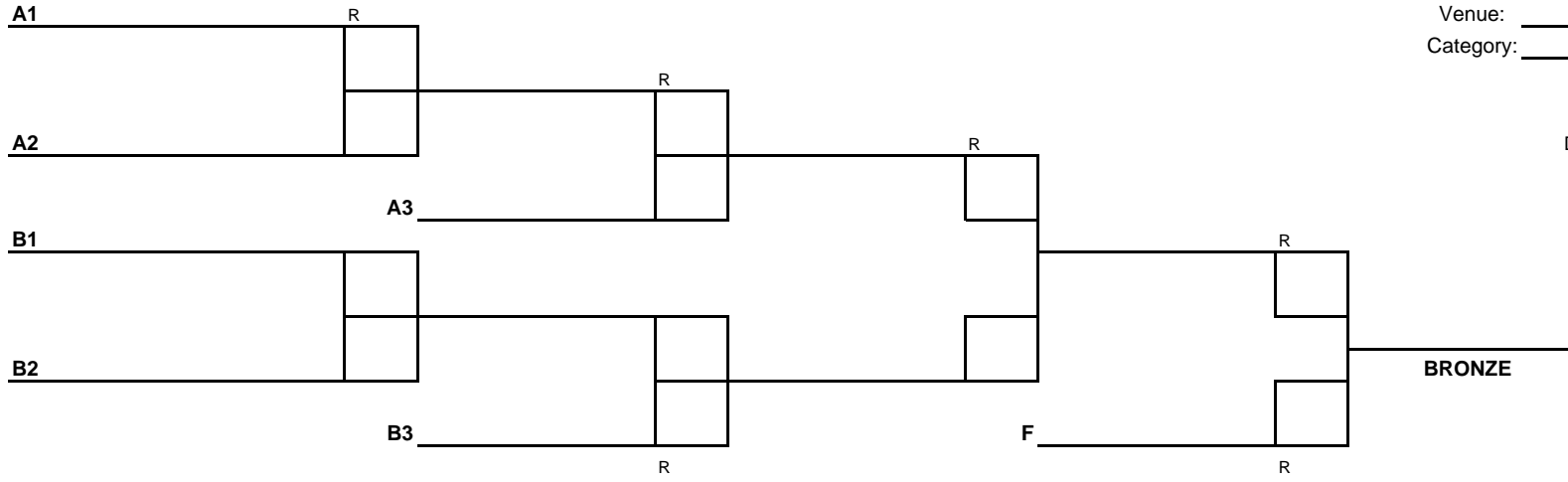

Referees _____

Table Officials _____

Knockout and Double Repechage for 33 to 64 Players

Date: _____
 Event: _____
 Venue: _____
 Category: _____

Duration of Contests: _____ Minutes

SECTION A

1				
33				
17				
49				
9				
41				
25				
57				

5				
37				
21				
53				
13				
45				
29				
61				

SECTION B

3				
35				
19				
51				
11				
43				
27				
59				

7				
39				
23				
55				
15				
47				
31				
63				

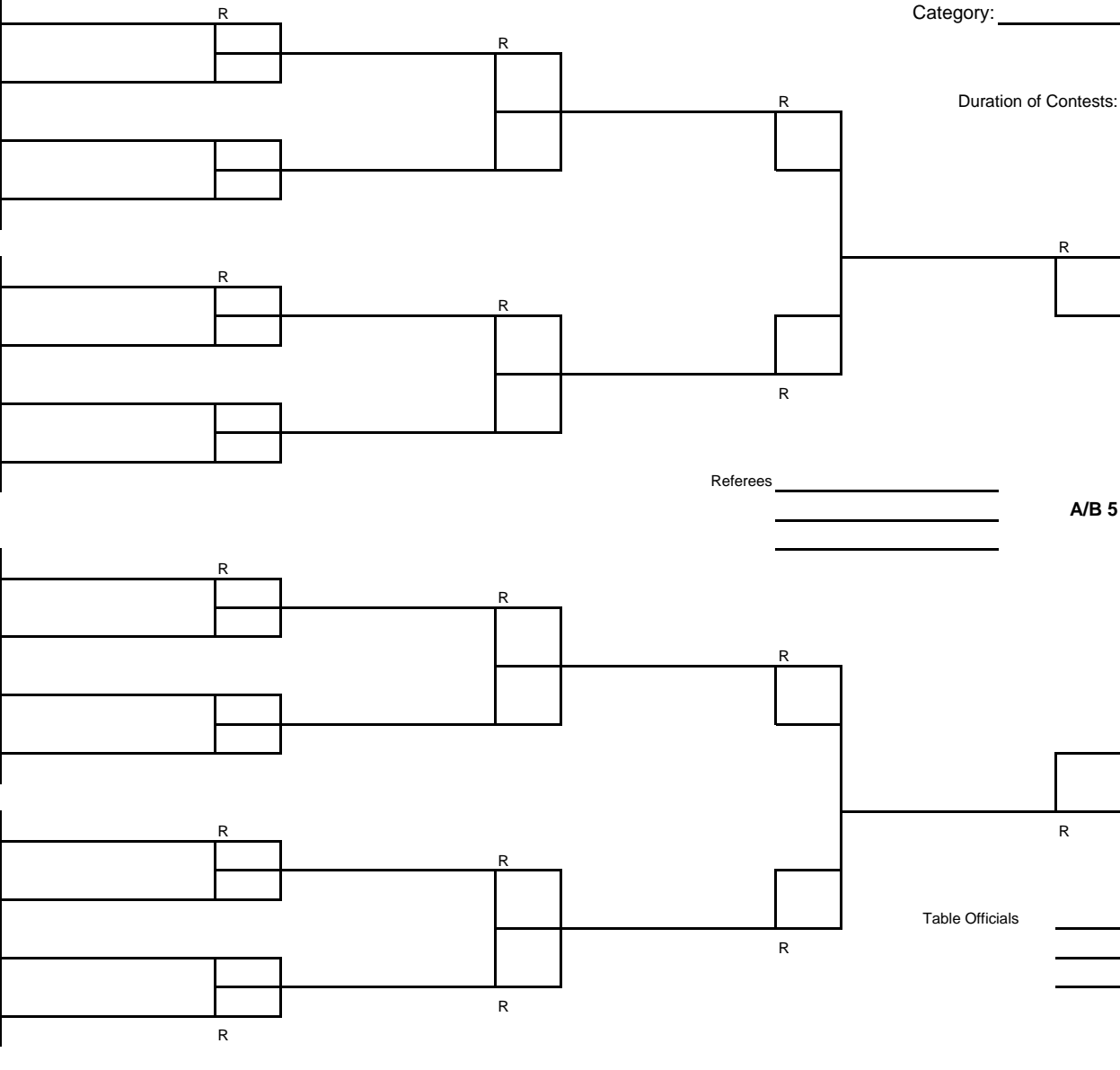

Referees _____

A/B 5
FINALIST

Table Officials _____

Knockout and Double Repechage for 33 to 64 Players

Date: _____
 Event: _____
 Venue: _____
 Category: _____

Duration of Contests: _____ Minutes

SECTION C

2				
34				
18				
50				
10				
42				
26				
58				

6				
38				
22				
54				
14				
46				
30				
62				

SECTION D

4				
36				
20				
52				
12				
44				
28				
60				

8				
40				
24				
56				
16				
48				
32				
64				

Referees _____

Table Officials _____

C/D5 **FINALIST**

R

Repechage Section of Knockout and Double Repechage for 33 to 64 Players

Date: _____
 Event: _____
 Venue: _____
 Category: _____

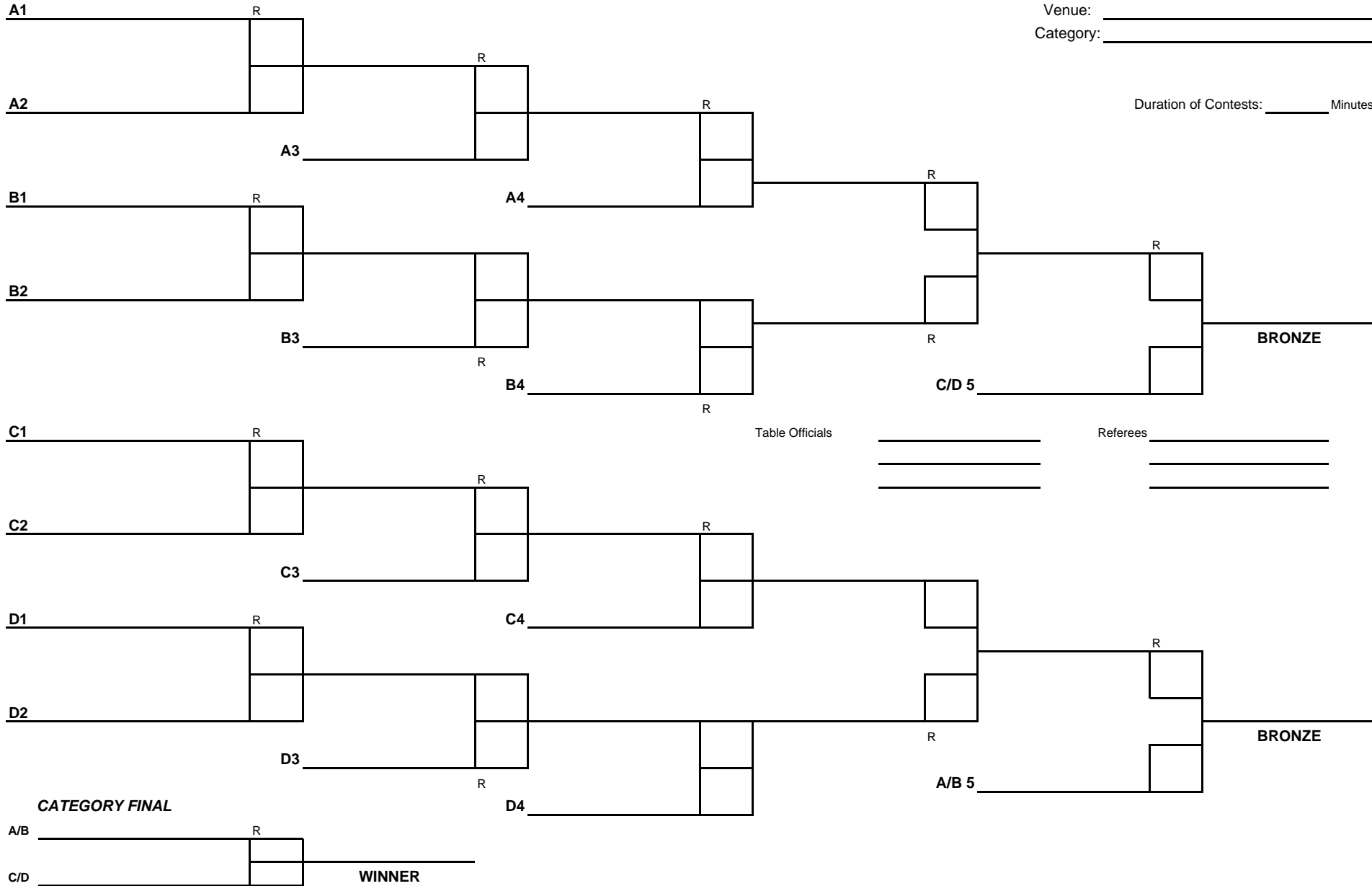

Knockout and Double Repechage for 65 to 128 Players

Date: _____
 Event: _____
 Venue: _____
 Category: _____

SECTION A

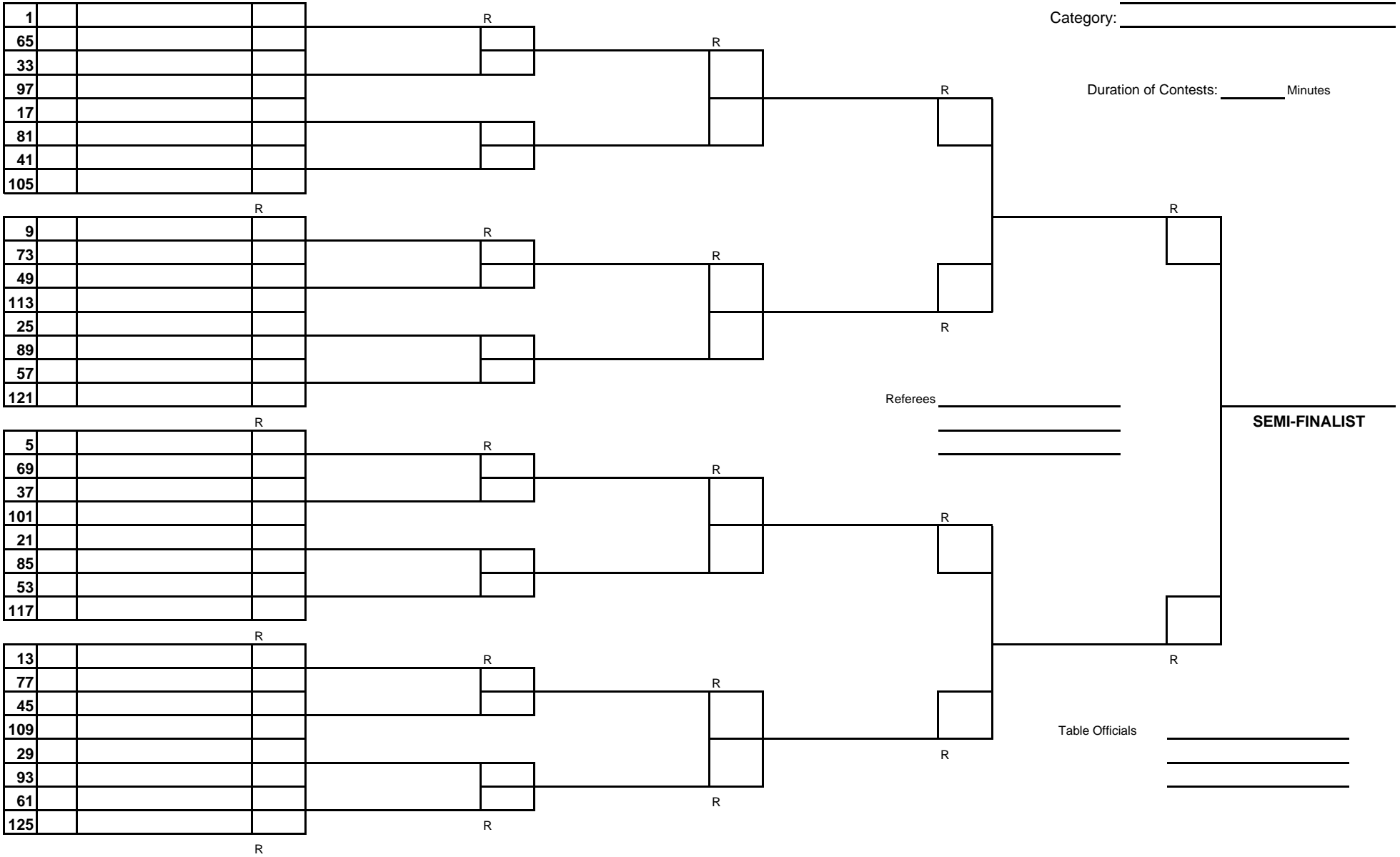

1			
65			
33			
97			
17			
81			
41			
105			

9			
73			
49			
113			
25			
89			
57			
121			

5			
69			
37			
101			
21			
85			
53			
117			

13			
77			
45			
109			
29			
93			
61			
125			

Knockout and Double Repechage for 65 to 128 Players

Date: _____
 Event: _____
 Venue: _____
 Category: _____

SECTION C

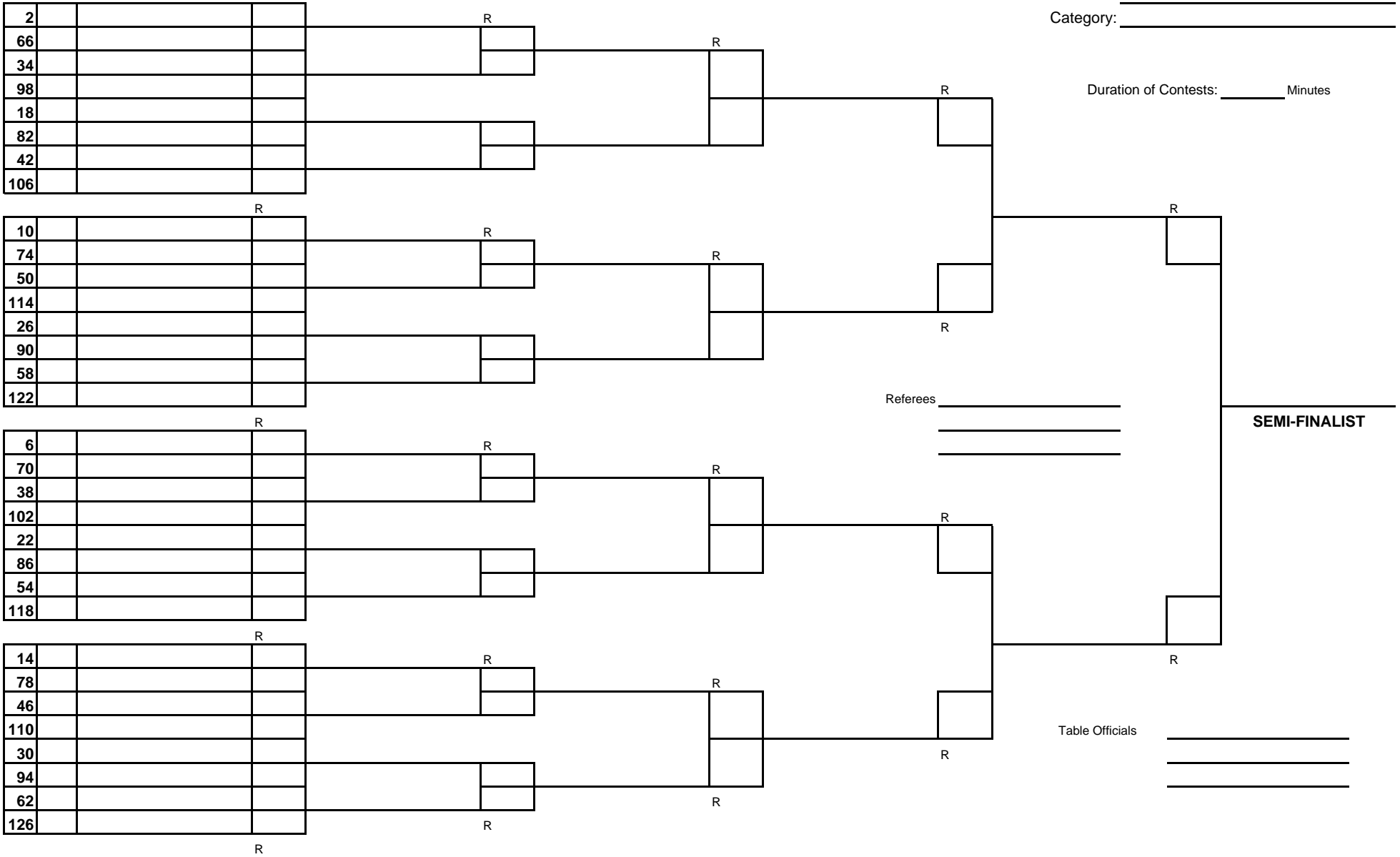

2			
66			
34			
98			
18			
82			
42			
106			

10			
74			
50			
114			
26			
90			
58			
122			

6			
70			
38			
102			
22			
86			
54			
118			

14			
78			
46			
110			
30			
94			
62			
126			

Knockout and Double Repechage for 65 to 128 Players

Date: _____
 Event: _____
 Venue: _____
 Category: _____

SECTION D

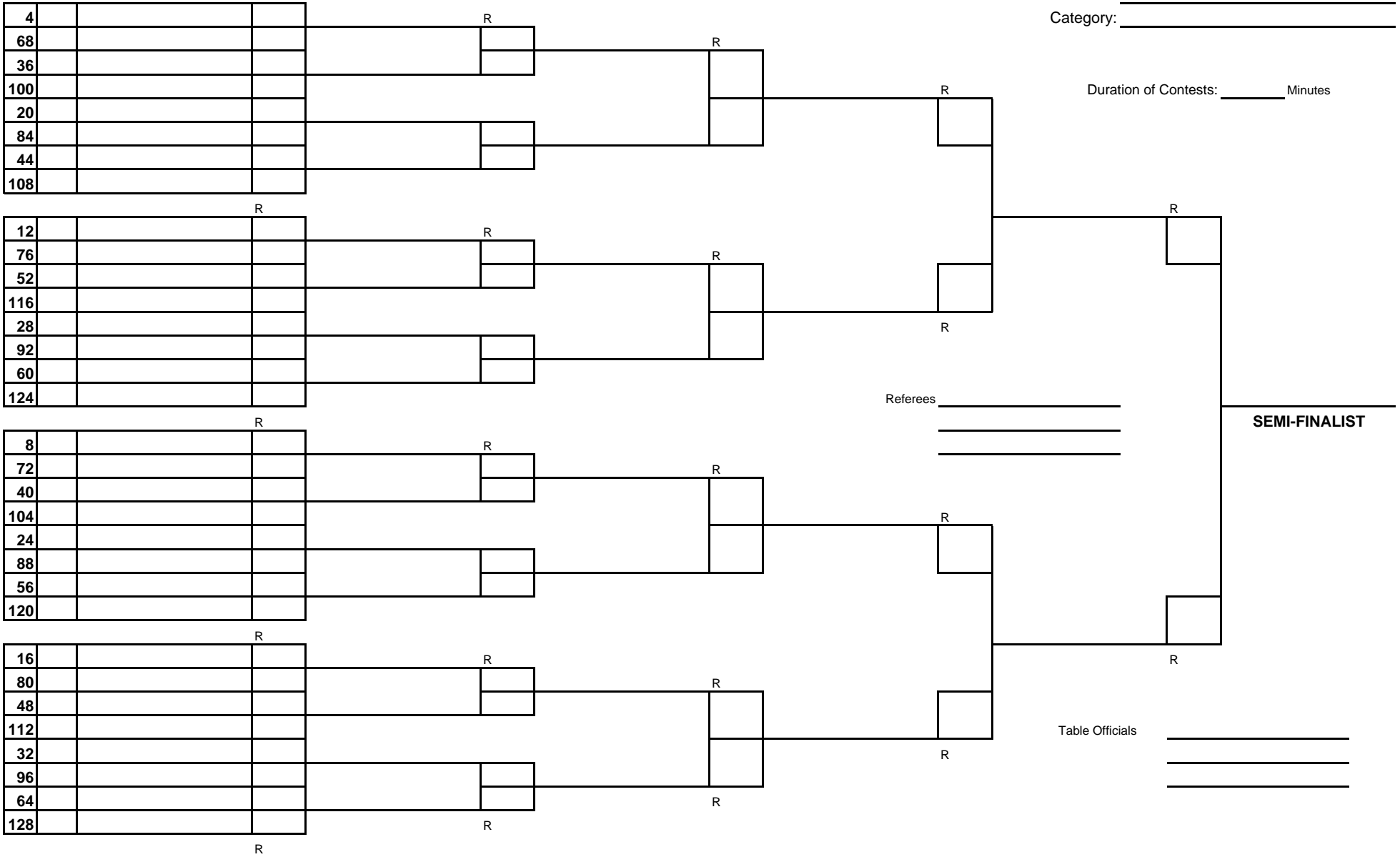

SEMI-FINALS AND FINAL TABLE for Knockout and Double Repechage for 65 to 128 Players

Date: _____
 Event: _____
 Venue: _____
 Category: _____

Duration of Contests: _____ Minutes

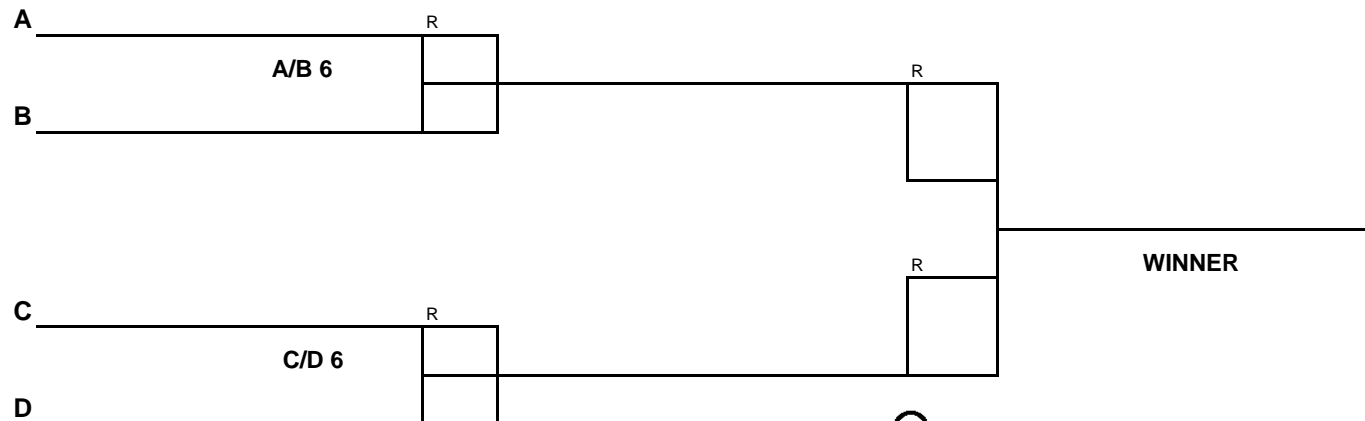
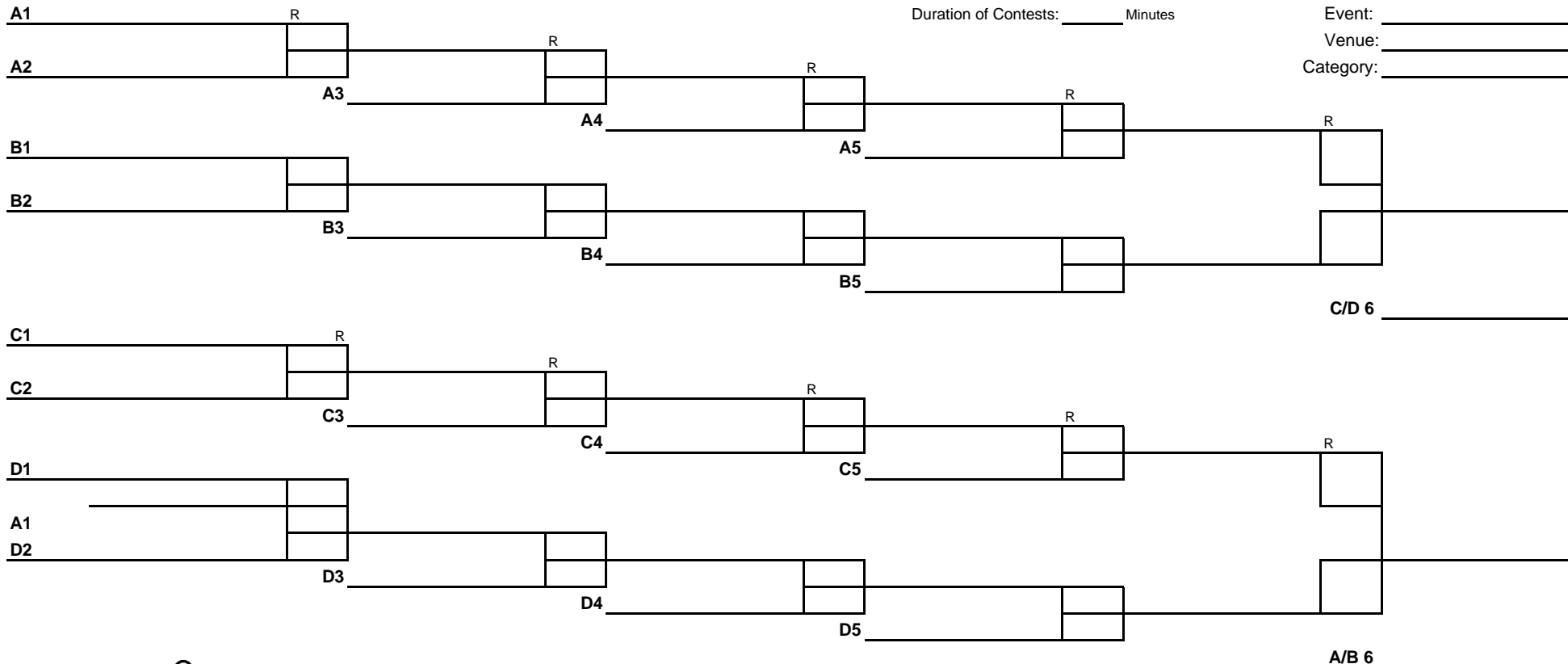

Table Officials _____

 Referees _____

Ⓣ	Win by an Ippon Throw	10
ⓓ	Win by an Ippon Hold	10
Ⓒ	Win by a Choke/Strangle	10
Ⓛ	Win by an Arm/Elbow Lock	10
T	Win by a Waza-Ari Throw	7
H	Win by a Waza-Ari Hold	7
S	Win by Superiority (Koka, Yuko or Hantei)	3 or 5 or 1
FG	Win by Fusen-Gachi (Non-appearance of opponent)	0
KG	Win by a Kiken-Gachi (Withdrawal of opponent due to injury)	10
SG	Win by Sege-Gachi (Compound Win)	10
HM	Win by Hansoku-Make (Direct)	10
△	Win by Hansoku-Make (Accumulated)	10
Ⓟ	Win by a Penalty (Shido, Chui, Keikoku Against Opponent)	7 or 5 or 3
D	Drawn Contest	0
L	Loss of Contest	0



- Ⓣ Win by an Ippon Throw 10
- Ⓜ Win by an Ippon Hold 10
- Ⓒ Win by a Choke/Strangle 10
- Ⓛ Win by an Arm/Elbow Lock 10
- Ⓣ Win by a Waza-Ari Throw 7
- Ⓜ Win by a Waza-Ari Hold 7
- Ⓢ Win by Superiority (Koka, Yuko or Hantei) 3 or 5 or 1
- FG Win by Fusen-Gachi (Non-appearance of opponent) 0
- KG Win by a Kiken-Gachi (Withdrawal of opponent due to injury) 10
- SG Win by Sego-Gachi (Compound Win) 10
- HM Win by Hansoku-Make (Direct) 10
- △ Win by Hansoku-Make (Accumulated) 10
- ▲ Win by a Penalty (Shido, Chui, Keikoku Against Opponent) 7 or 5 or 3
- D Drawn Contest 0
- L Loss of Contest 0

Referees _____

Table Officials _____

