



IJF Grandprix Rotterdam 2010

(NED Rotterdam, 15-17 October 2010)

-60 kg

26 Judoka

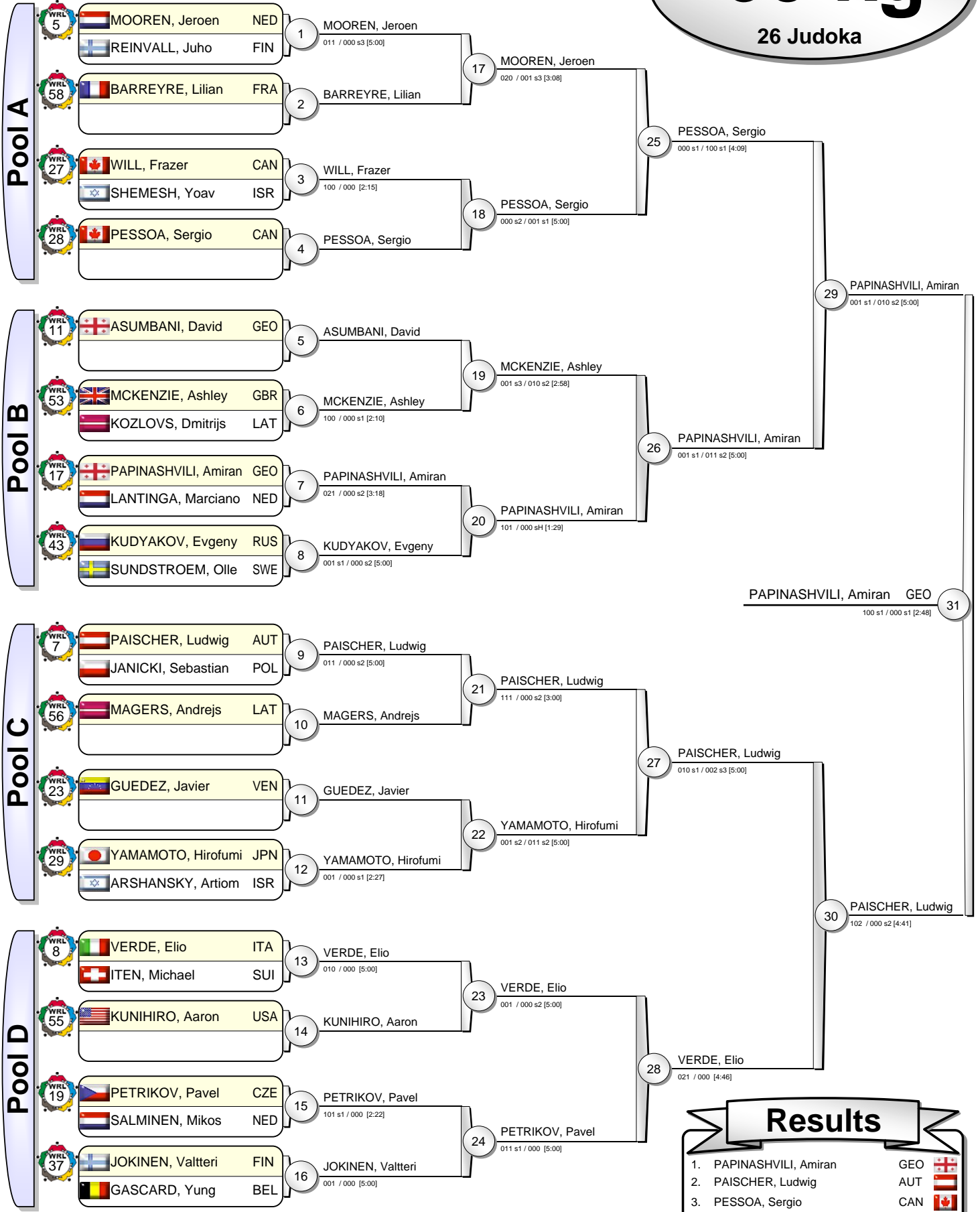

Results

- | | | |
|-------------------------|-----|--|
| 1. PAPINASHVILI, Amiran | GEO | |
| 2. PAISCHER, Ludwig | AUT | |
| 3. PESSOA, Sergio | CAN | |
| 3. VERDE, Elio | ITA | |
| 5. MOOREN, Jeroen | NED | |
| 5. MCKENZIE, Ashley | GBR | |
| 5. YAMAMOTO, Hirofumi | JPN | |
| 5. PETRIKOV, Pavel | CZE | |



IJF Grandprix Rotterdam 2010

(NED Rotterdam, 15-17 October 2010)

-66 kg

26 Judoka

Pool A

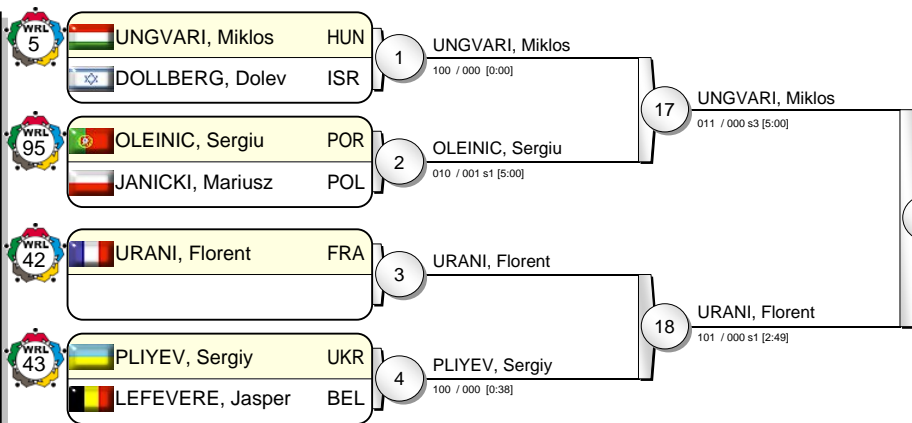

Pool B

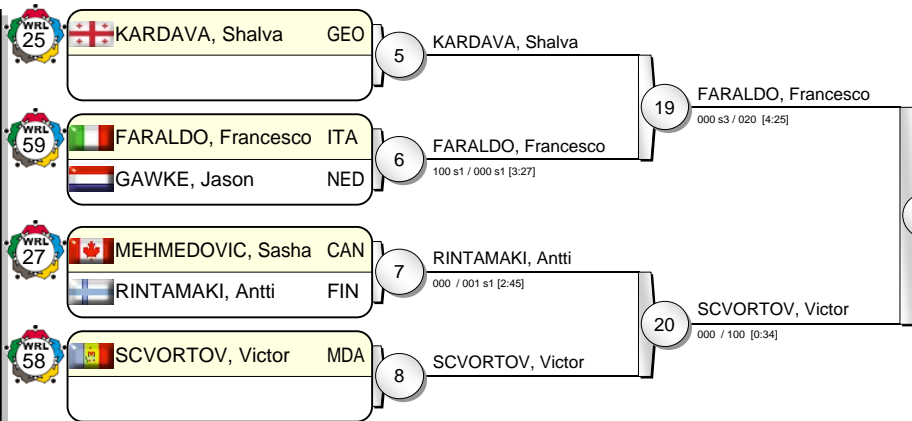

Pool C

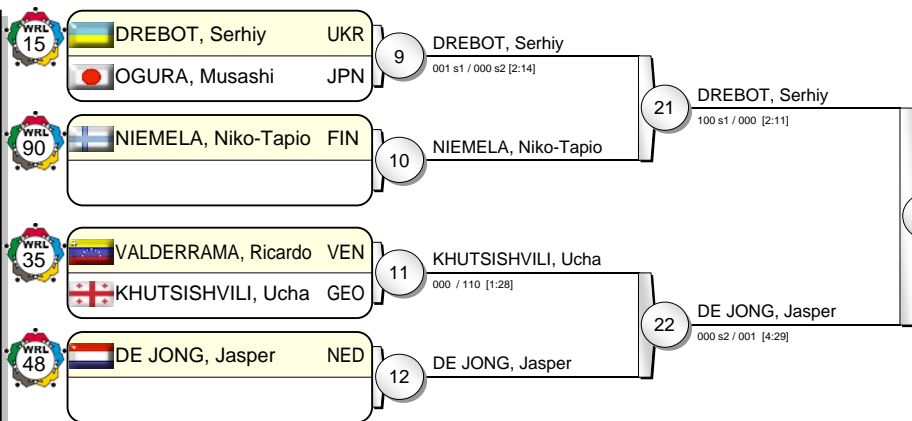

Pool D

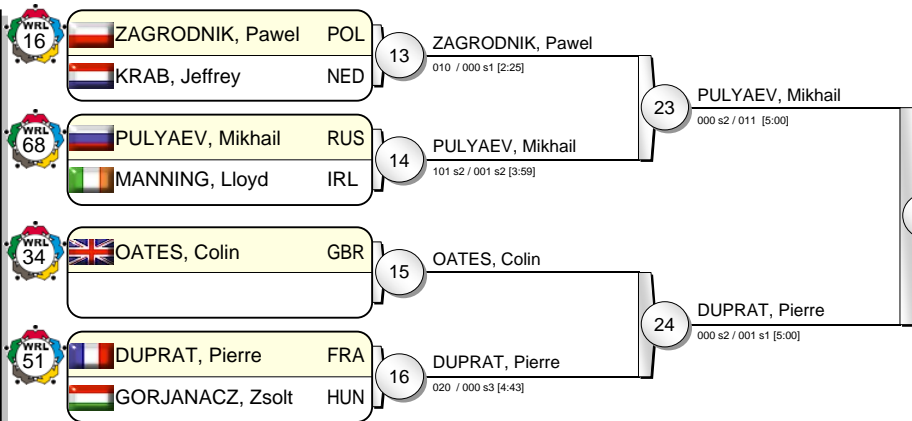

PULYAEV, Mikhail RUS 31
001 s2 / 002 s2 [5:00]

Results

- | | | | |
|----|--------------------|-----|--|
| 1. | PULYAEV, Mikhail | RUS | |
| 2. | FARALDO, Francesco | ITA | |
| 3. | UNGVARI, Miklos | HUN | |
| 3. | DREBOT, Serhiy | UKR | |
| 5. | URANI, Florent | FRA | |
| 5. | SCVORTOV, Victor | MDA | |
| 5. | DE JONG, Jasper | NED | |
| 5. | DUPRAT, Pierre | FRA | |



IJF Grandprix Rotterdam 2010

(NED Rotterdam, 15-17 October 2010)

-73 kg

32 Judoka

Pool A

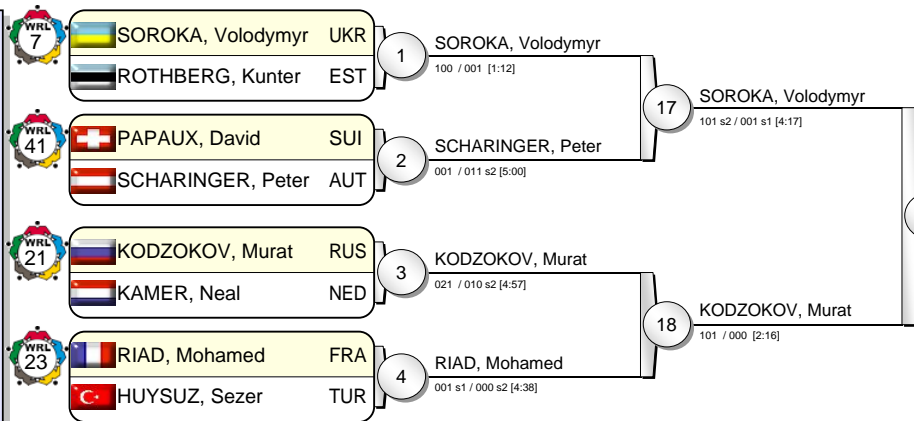

Pool B

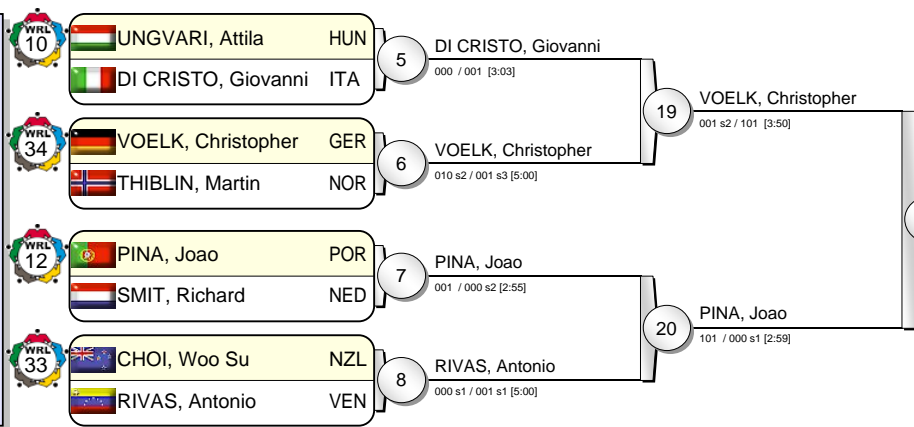

Pool C

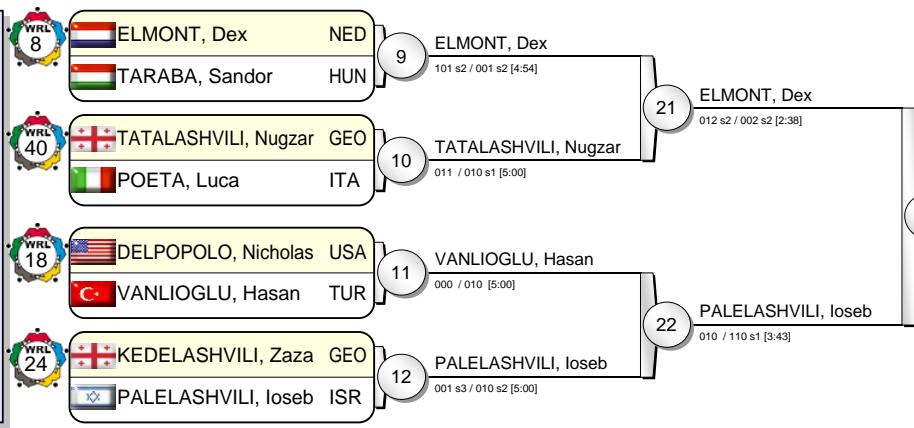

Pool D

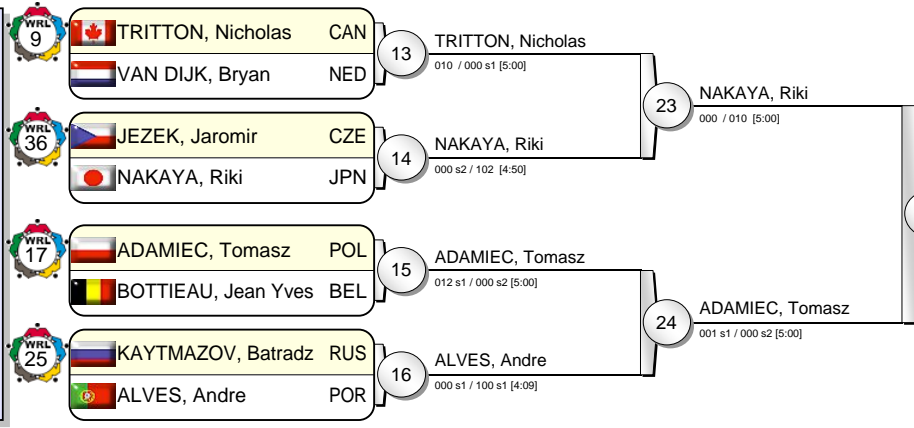

PINA, Joao POR 31
002 / 000 [5:00]

Results

- | | | |
|------------------------|-----|--|
| 1. PINA, Joao | POR | |
| 2. ELMONT, Dex | NED | |
| 3. KODZOKOV, Murat | RUS | |
| 3. ADAMIEC, Tomasz | POL | |
| 5. SOROKA, Volodymyr | UKR | |
| 5. VOELK, Christopher | GER | |
| 5. PALELASHVILI, Ioseb | ISR | |
| 5. NAKAYA, Riki | JPN | |



IJF Grandprix Rotterdam 2010

(NED Rotterdam, 15-17 October 2010)

-81 kg

38 Judoka

Pool A

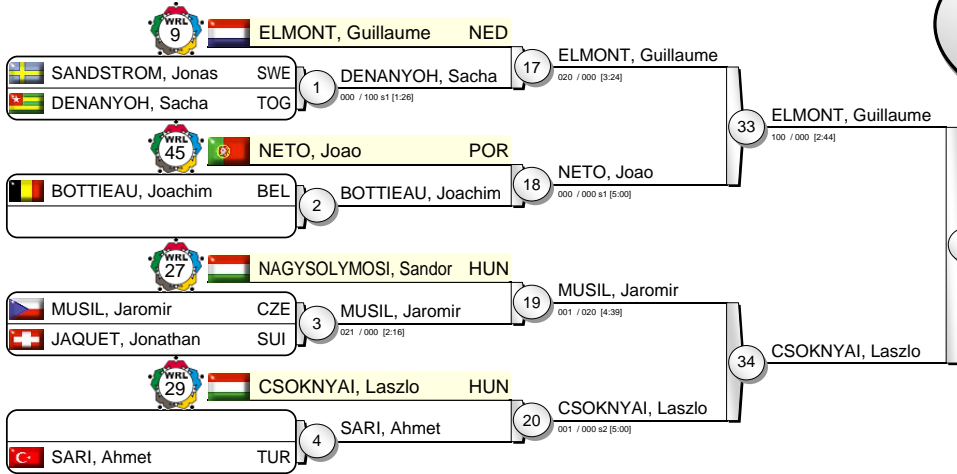

Pool B

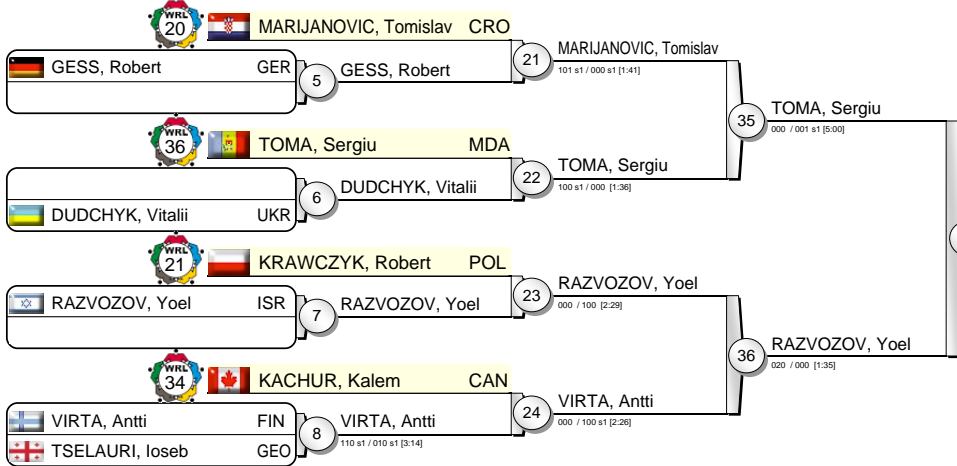

Pool C

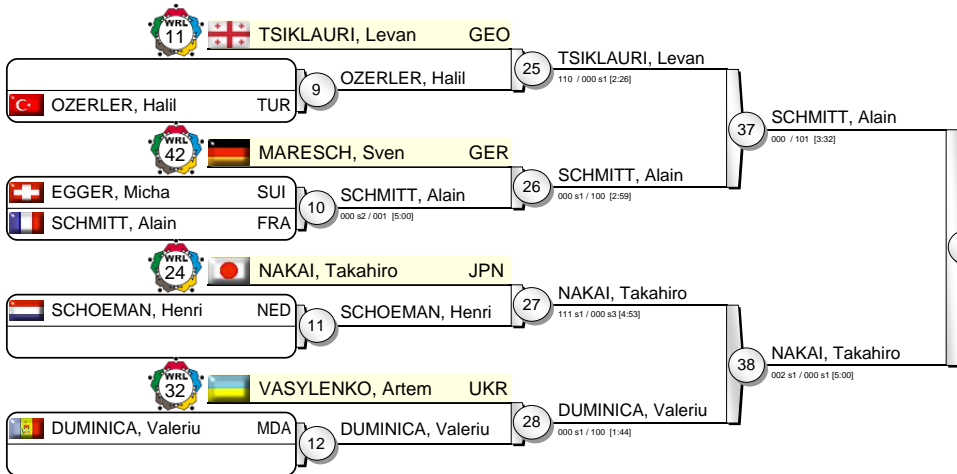

Pool D

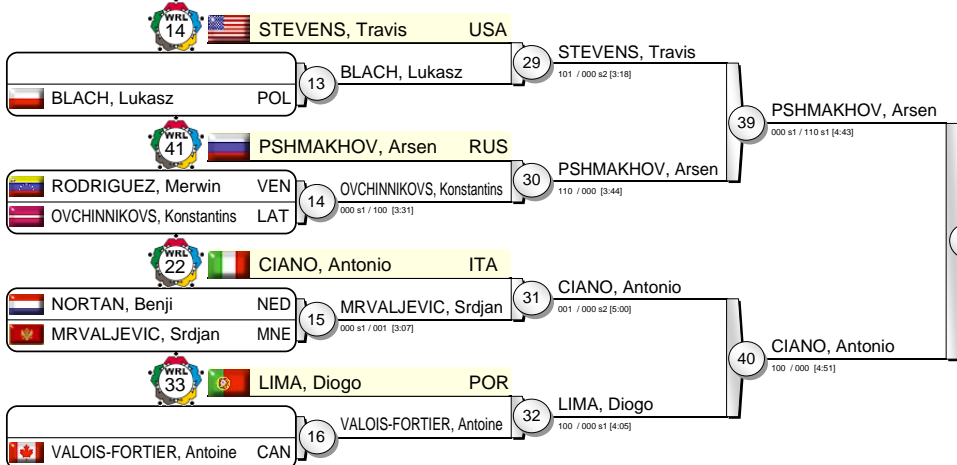

ELMONT, Guillaume (47)

Results

- ELMONT, Guillaume
- NAKAI, Takahiro
- TOMA, Sergiu
- CIANO, Antonio
- CSOKNYAI, Laszlo
- RAZVOZOV, Yoel
- SCHMITT, Alain
- PSHMAKHOV, Arsen



IJF Grandprix Rotterdam 2010

(NED Rotterdam, 15-17 October 2010)

-90 kg

23 Judoka

Pool A

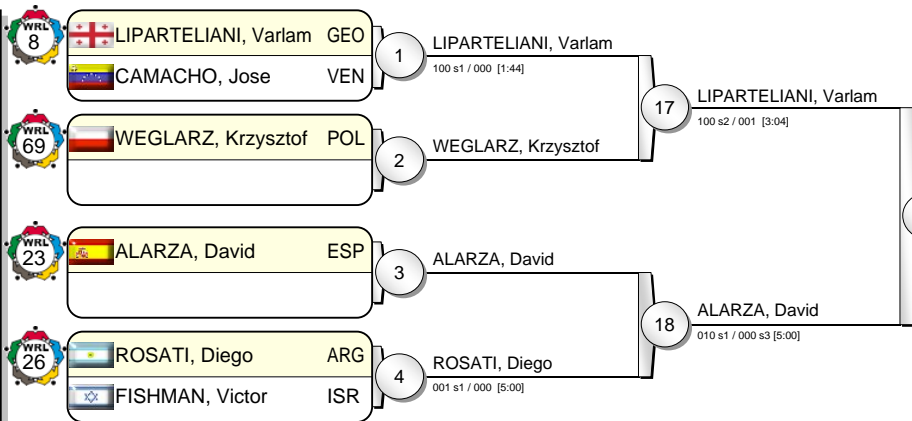

Pool B

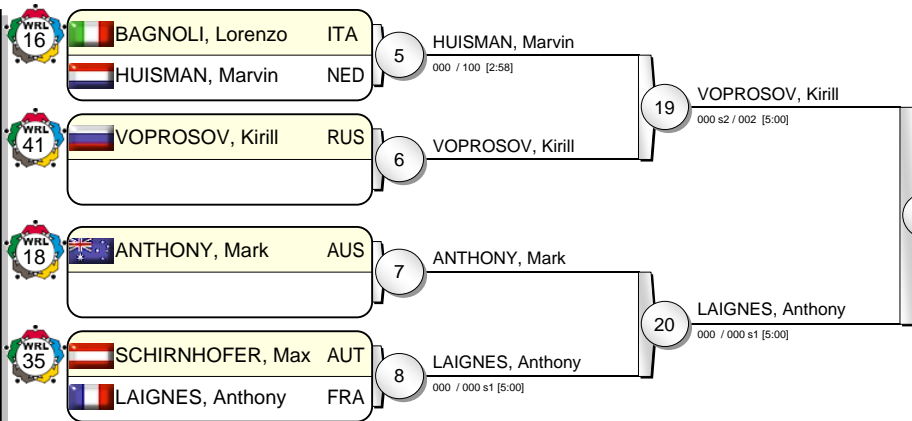

Pool C

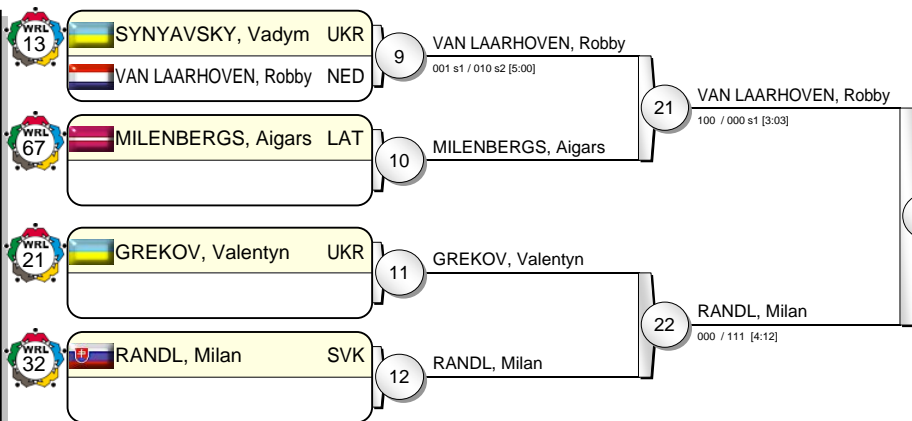

Pool D

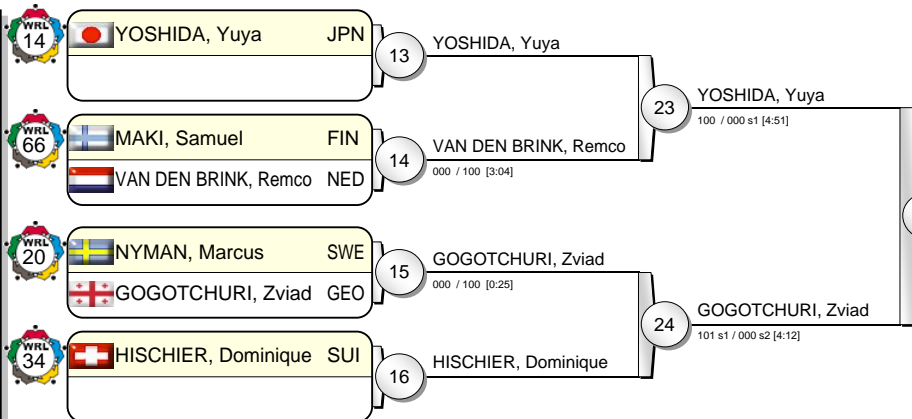

YOSHIDA, Yuya JPN 31

30 YOSHIDA, Yuya 000 / 100 [1:12]

Results

- | | | |
|-------------------------|-----|--|
| 1. YOSHIDA, Yuya | JPN | |
| 2. LIPARTELIANI, Varlam | GEO | |
| 3. VOPROSOV, Kirill | RUS | |
| 3. RANDL, Milan | SVK | |
| 5. ALARZA, David | ESP | |
| 5. LAIGNES, Anthony | FRA | |
| 5. VAN LAARHOVEN, Robby | NED | |
| 5. GOGOTCHURI, Zviad | GEO | |



IJF Grandprix Rotterdam 2010

(NED Rotterdam, 15-17 October 2010)

-100 kg

13 Judoka

Pool A

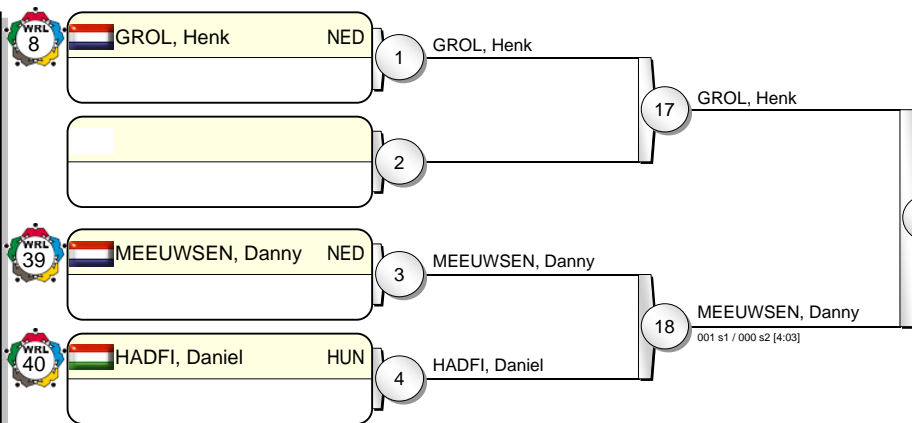

Pool B

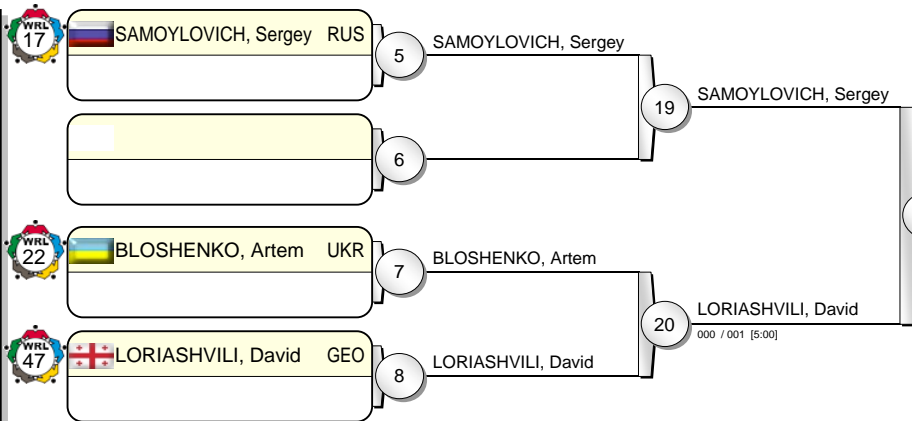

Pool C

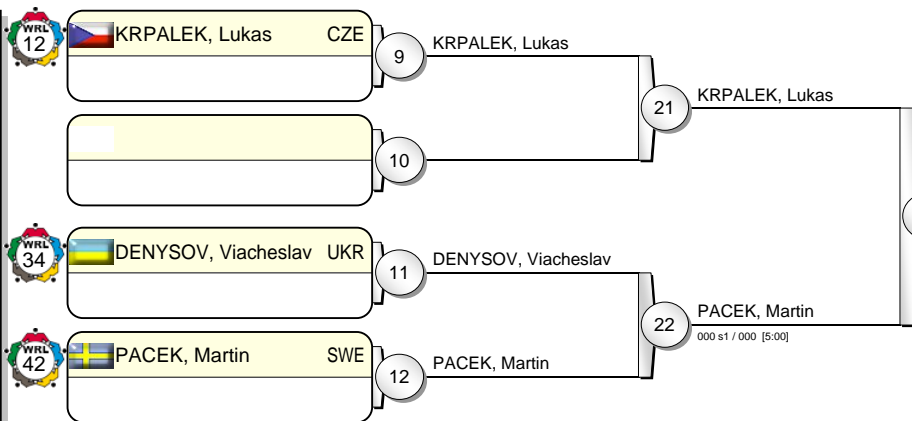

Pool D

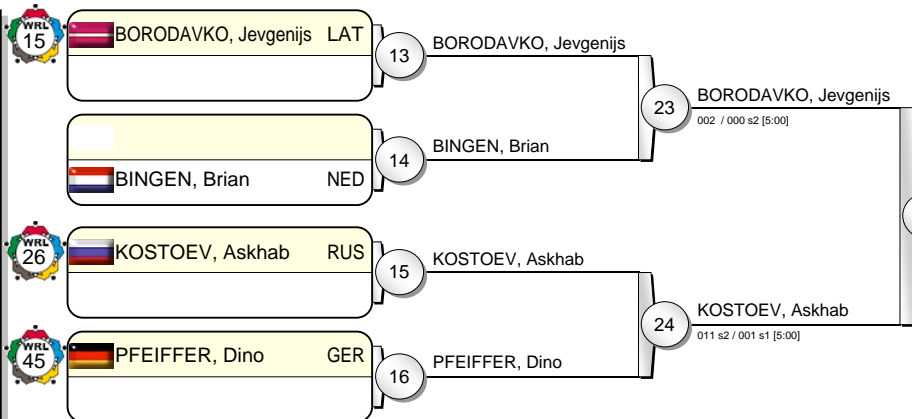

GROL, Henk NED 31
001 s1 / 000 s2 [5:00]

Results

- | | | | |
|----|----------------------|-----|--|
| 1. | GROL, Henk | NED | |
| 2. | BORODAVKO, Jevgenijs | LAT | |
| 3. | SAMOYLOVICH, Sergey | RUS | |
| 3. | PACEK, Martin | SWE | |
| 5. | MEEUWSEN, Danny | NED | |
| 5. | LORIASHVILI, David | GEO | |
| 5. | KRPALEK, Lukas | CZE | |
| 5. | KOSTOEV, Askhab | RUS | |



IJF Grandprix Rotterdam 2010

(NED Rotterdam, 15-17 October 2010)

+100 kg

12 Judoka

Pool A

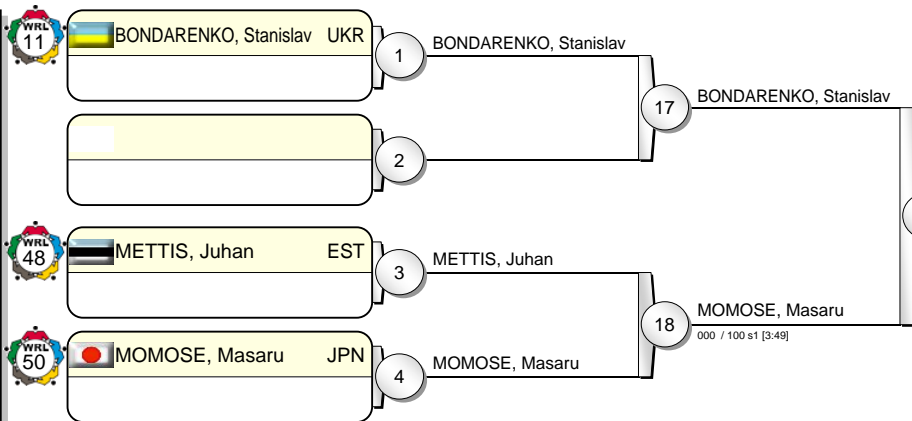

Pool B

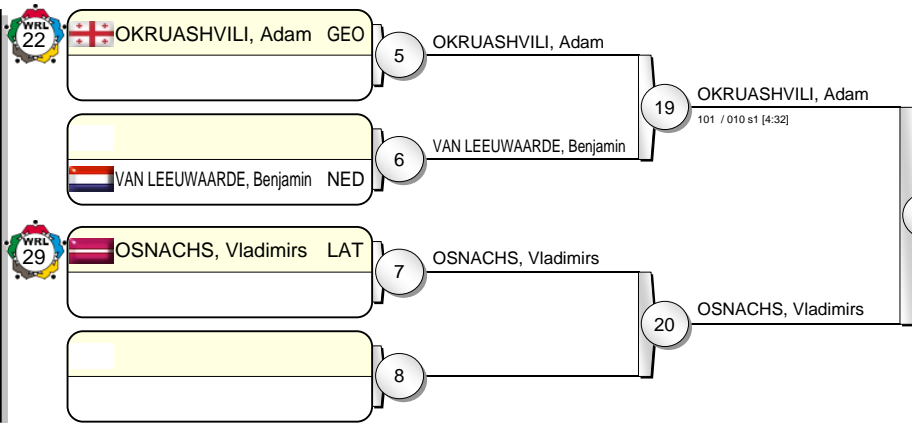

Pool C

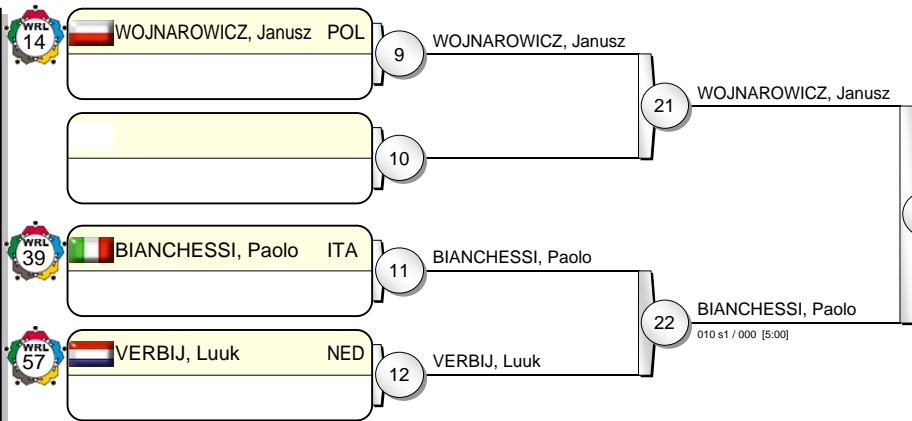

Pool D

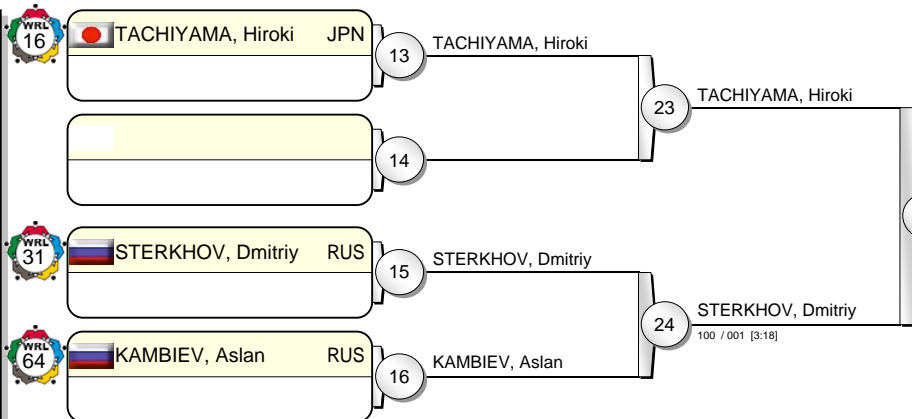

TACHIYAMA, Hiroki JPN 31
010 / 100 [2:30]

30 TACHIYAMA, Hiroki
000 s1 / 100 [3:52]

Results

- | | | |
|--------------------------|-----|--|
| 1. TACHIYAMA, Hiroki | JPN | |
| 2. OSNACHS, Vladimirs | LAT | |
| 3. BONDARENKO, Stanislav | UKR | |
| 3. BIANCHESSI, Paolo | ITA | |
| 5. MOMOSE, Masaru | JPN | |
| 5. OKRUASHVILI, Adam | GEO | |
| 5. WOJNAROWICZ, Janusz | POL | |
| 5. STERKHOV, Dmitriy | RUS | |



IJF Grandprix Rotterdam 2010

(NED Rotterdam, 15-17 October 2010)

-48 kg

21 Judoka

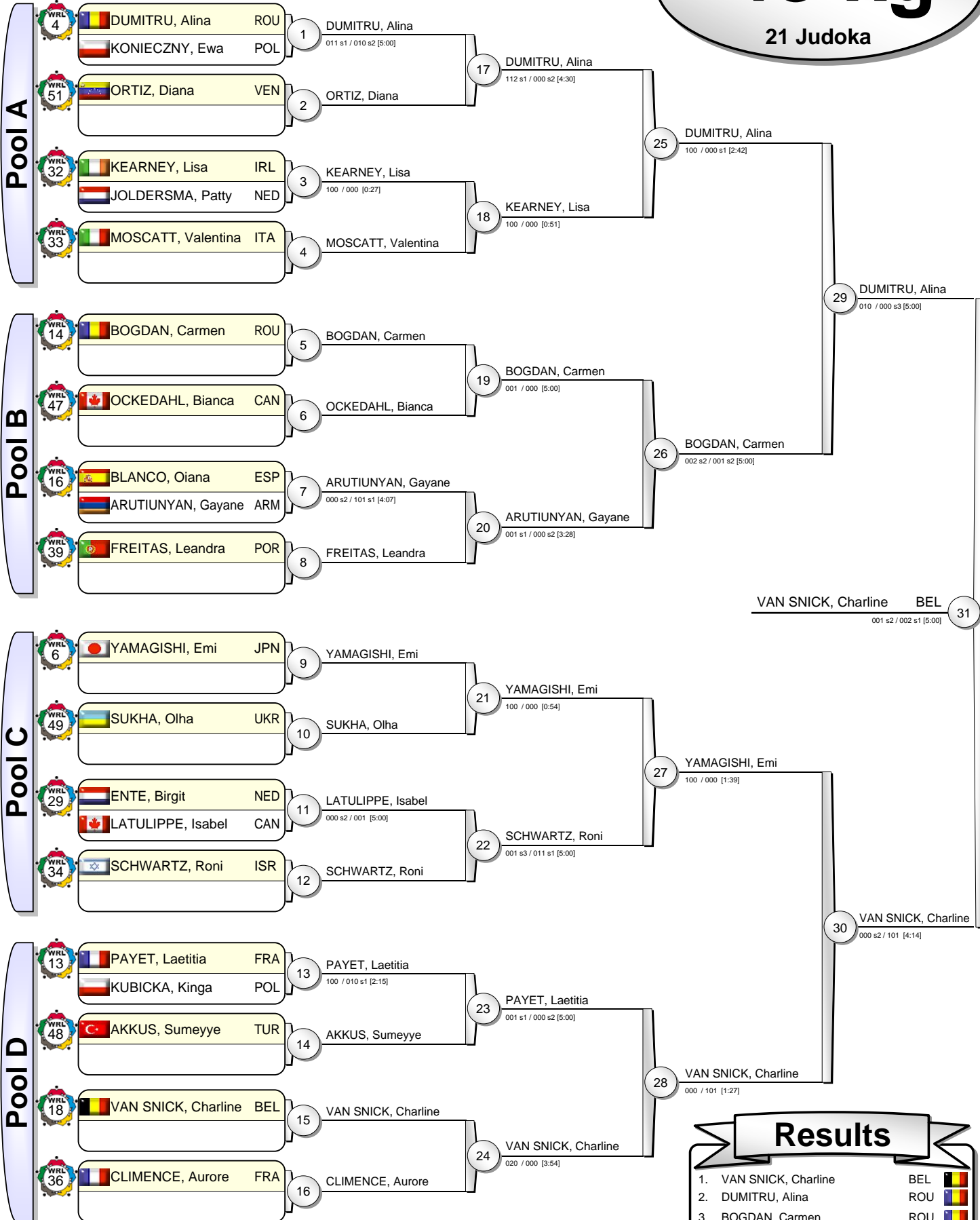

Results

- | | | |
|------------------------|-----|--|
| 1. VAN SNICK, Charline | BEL | |
| 2. DUMITRU, Alina | ROU | |
| 3. BOGDAN, Carmen | ROU | |
| 3. YAMAGISHI, Emi | JPN | |
| 5. KEARNEY, Lisa | IRL | |
| 5. ARUTIUNYAN, Gayane | ARM | |
| 5. SCHWARTZ, Roni | ISR | |
| 5. PAYET, Laetitia | FRA | |



IJF Grandprix Rotterdam 2010

(NED Rotterdam, 15-17 October 2010)

-52 kg

16 Judoka

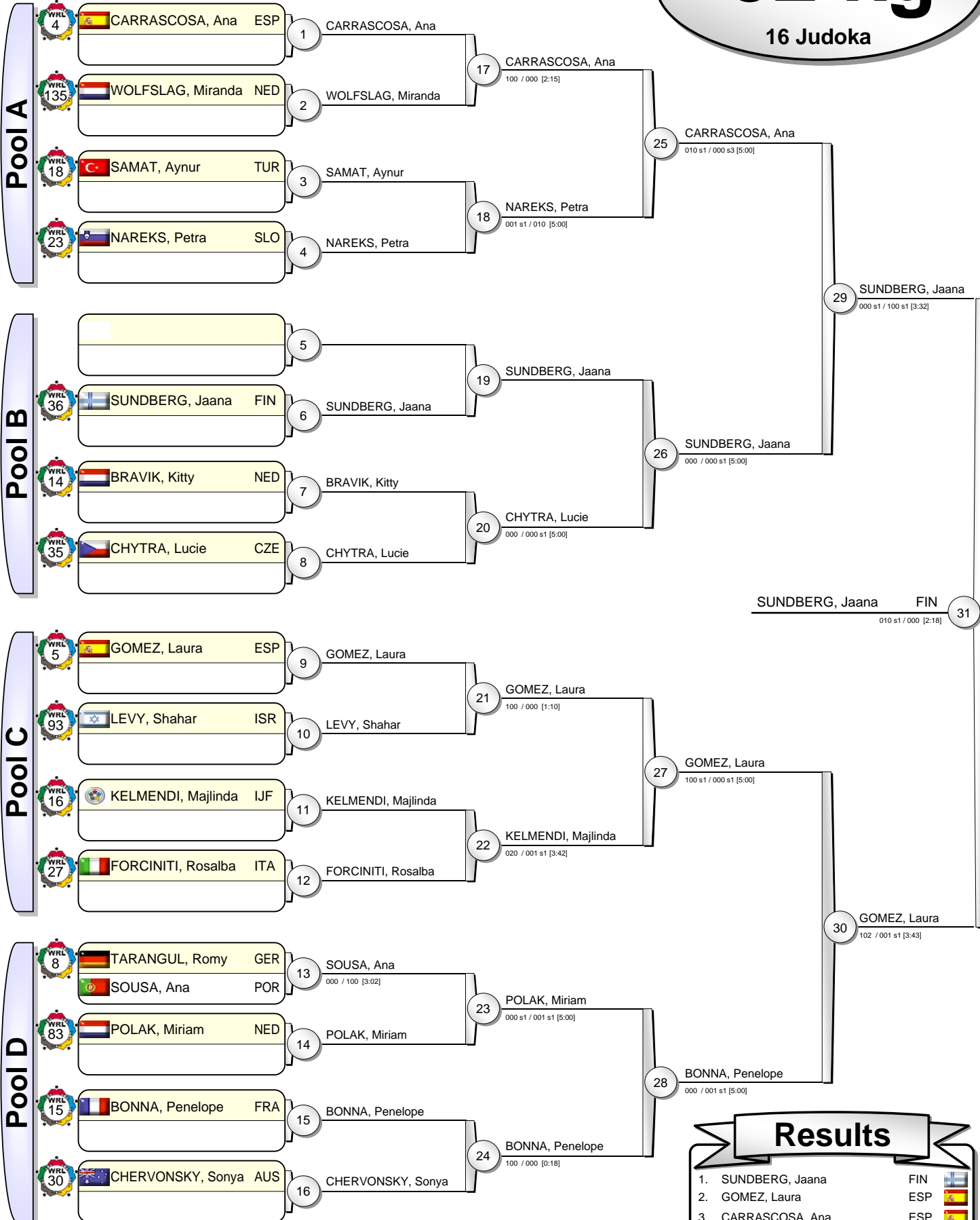

SUNDBERG, Jaana FIN 31
010 s1 / 000 [2:18]

Results

- | | | |
|-----------------------|-----|--|
| 1. SUNDBERG, Jaana | FIN | |
| 2. GOMEZ, Laura | ESP | |
| 3. CARRASCOSA, Ana | ESP | |
| 3. BONNA, Penelope | FRA | |
| 5. NAREKS, Petra | SLO | |
| 5. CHYTRA, Lucie | CZE | |
| 5. KELMENDI, Majlinda | IJF | |
| 5. POLAK, Miriam | NED | |



IJF Grandprix Rotterdam 2010

(NED Rotterdam, 15-17 October 2010)

-57 kg

20 Judoka

Pool A

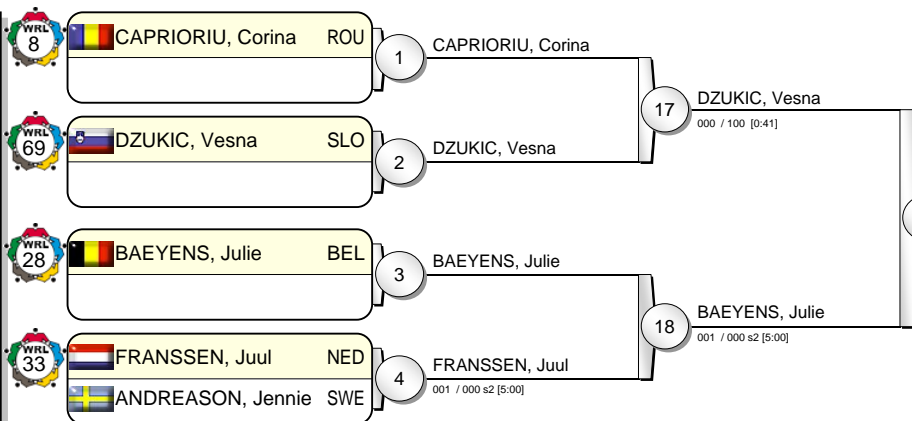

Pool B

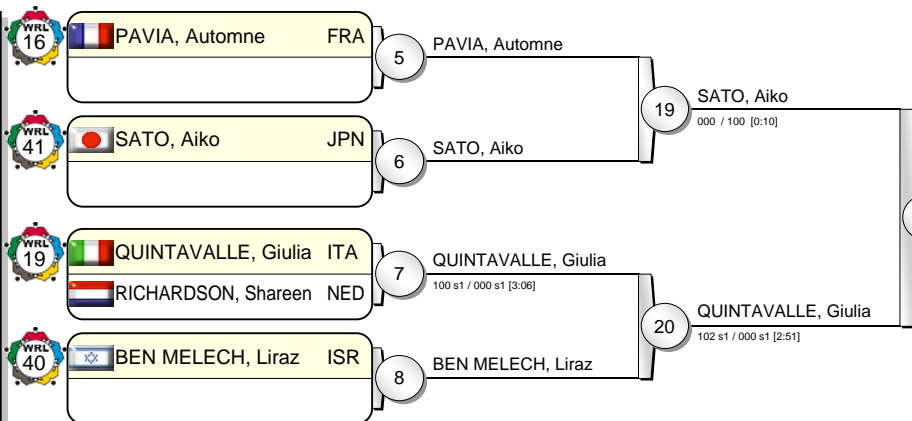

Pool C

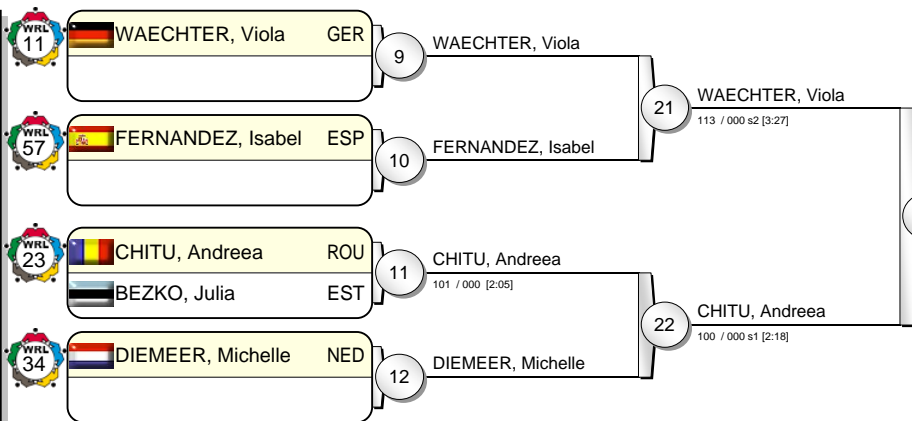

Pool D

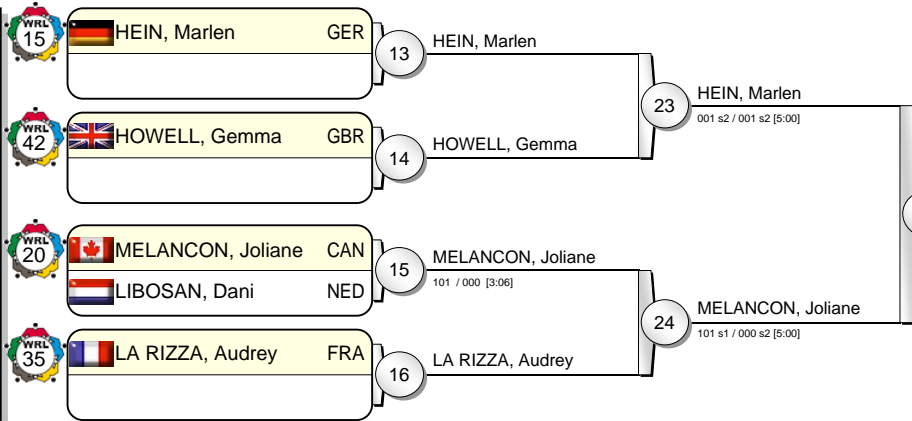

SATO, Aiko JPN (31) 100 / 000 [0:10]

Results

- | | | |
|------------------------|-----|--|
| 1. SATO, Aiko | JPN | |
| 2. HEIN, Marlen | GER | |
| 3. DZUKIC, Vesna | SLO | |
| 3. WAECHTER, Viola | GER | |
| 5. BAEYENS, Julie | BEL | |
| 5. QUINTAVALLE, Giulia | ITA | |
| 5. CHITU, Andreea | ROU | |
| 5. MELANCON, Joliane | CAN | |



IJF Grandprix Rotterdam 2010

(NED Rotterdam, 15-17 October 2010)

-63 kg

19 Judoka

Pool A

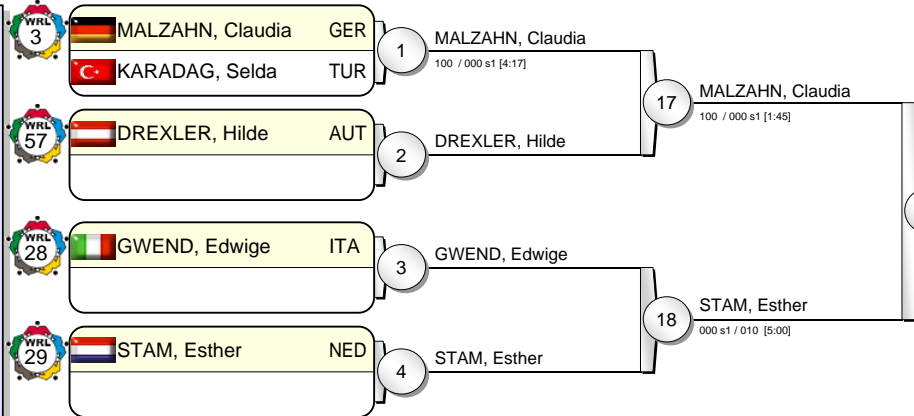

Pool B

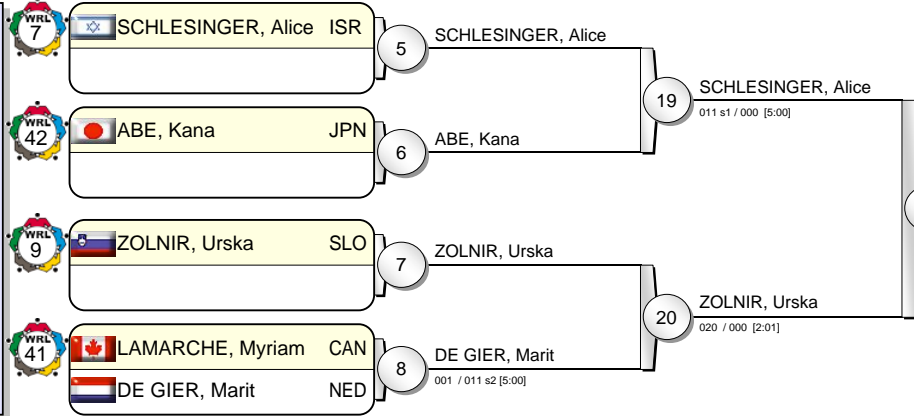

Pool C

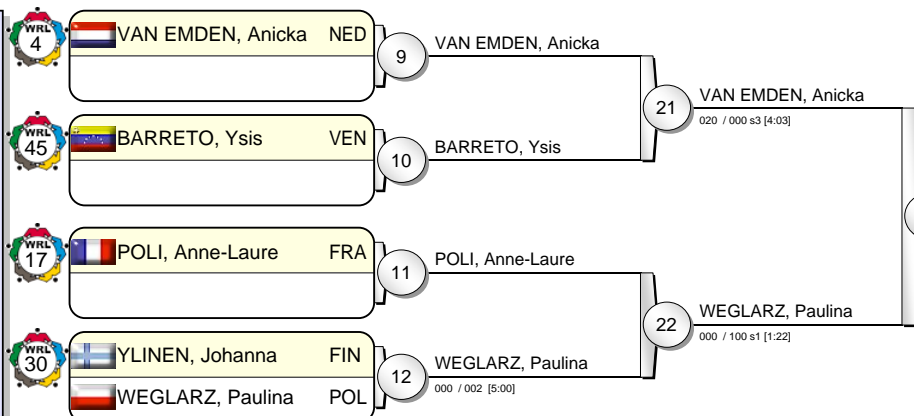

Pool D

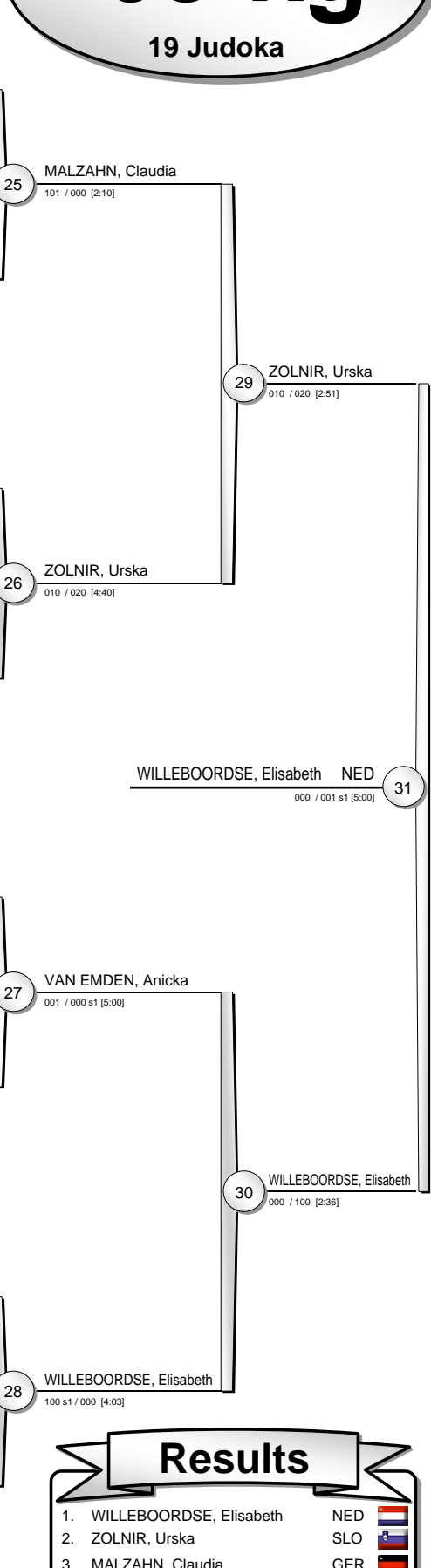
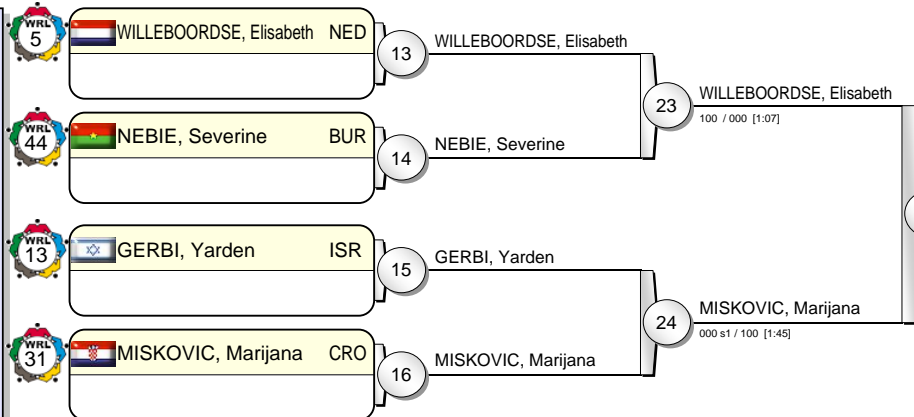

WILLEBOORDSE, Elisabeth NED 000 / 001 s1 [5:00] 31

Results

- | | | | |
|----|-------------------------|-----|--|
| 1. | WILLEBOORDSE, Elisabeth | NED | |
| 2. | ZOLNIR, Urska | SLO | |
| 3. | MALZAHN, Claudia | GER | |
| 3. | VAN EMDEN, Anicka | NED | |
| 5. | STAM, Esther | NED | |
| 5. | SCHLESINGER, Alice | ISR | |
| 5. | WEGLARZ, Paulina | POL | |
| 5. | MISKOVIC, Marijana | CRO | |



IJF Grandprix Rotterdam 2010

(NED Rotterdam, 15-17 October 2010)

-70 kg

16 Judoka

Pool A

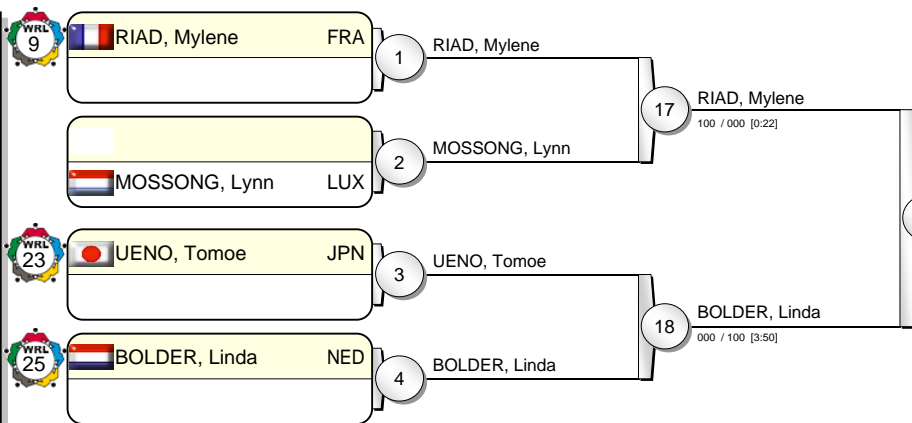

Pool B

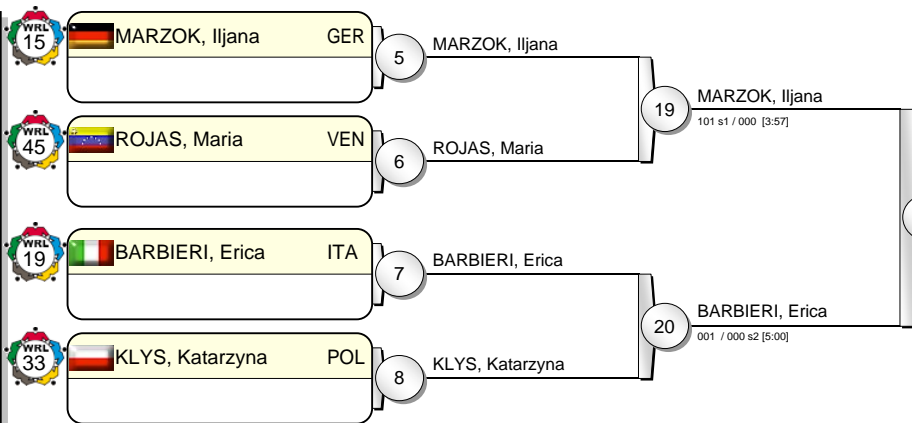

Pool C

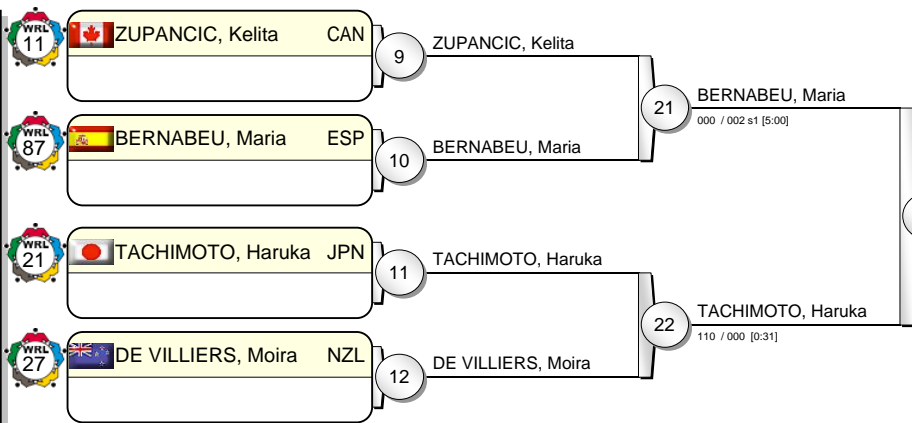

Pool D

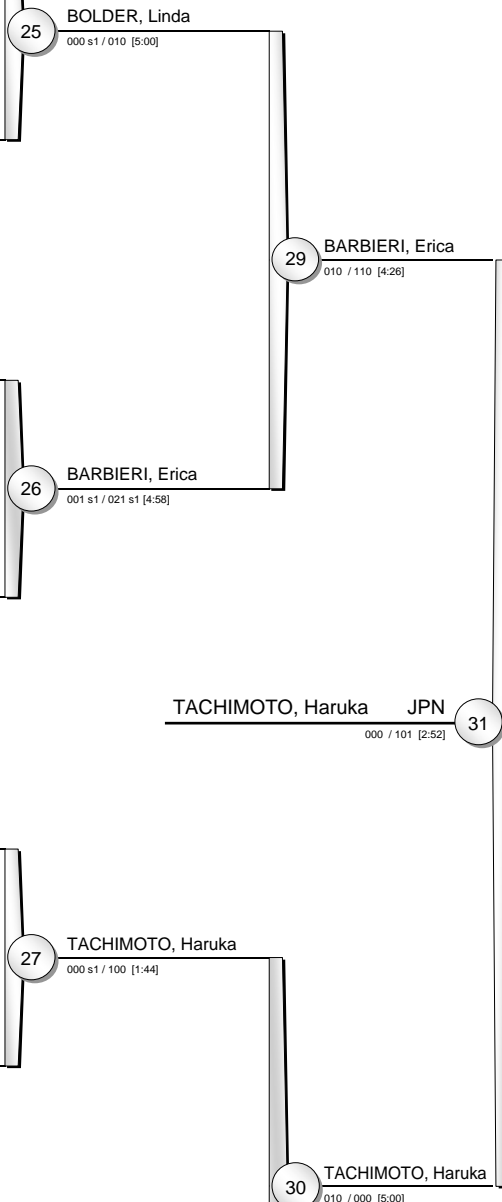
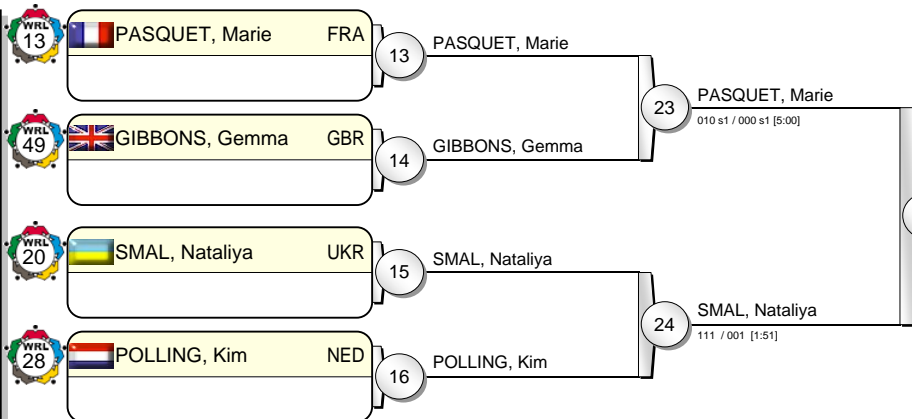

TACHIMOTO, Haruka JPN
000 / 101 [2:52] 31

Results

- | | | |
|----------------------|-----|--|
| 1. TACHIMOTO, Haruka | JPN | |
| 2. BARBIERI, Erica | ITA | |
| 3. BOLDER, Linda | NED | |
| 3. PASQUET, Marie | FRA | |
| 5. RIAD, Mylene | FRA | |
| 5. MARZOK, Iljana | GER | |
| 5. BERNABEU, Maria | ESP | |
| 5. SMAL, Nataliya | UKR | |



IJF Grandprix Rotterdam 2010

(NED Rotterdam, 15-17 October 2010)

-78 kg

18 Judoka

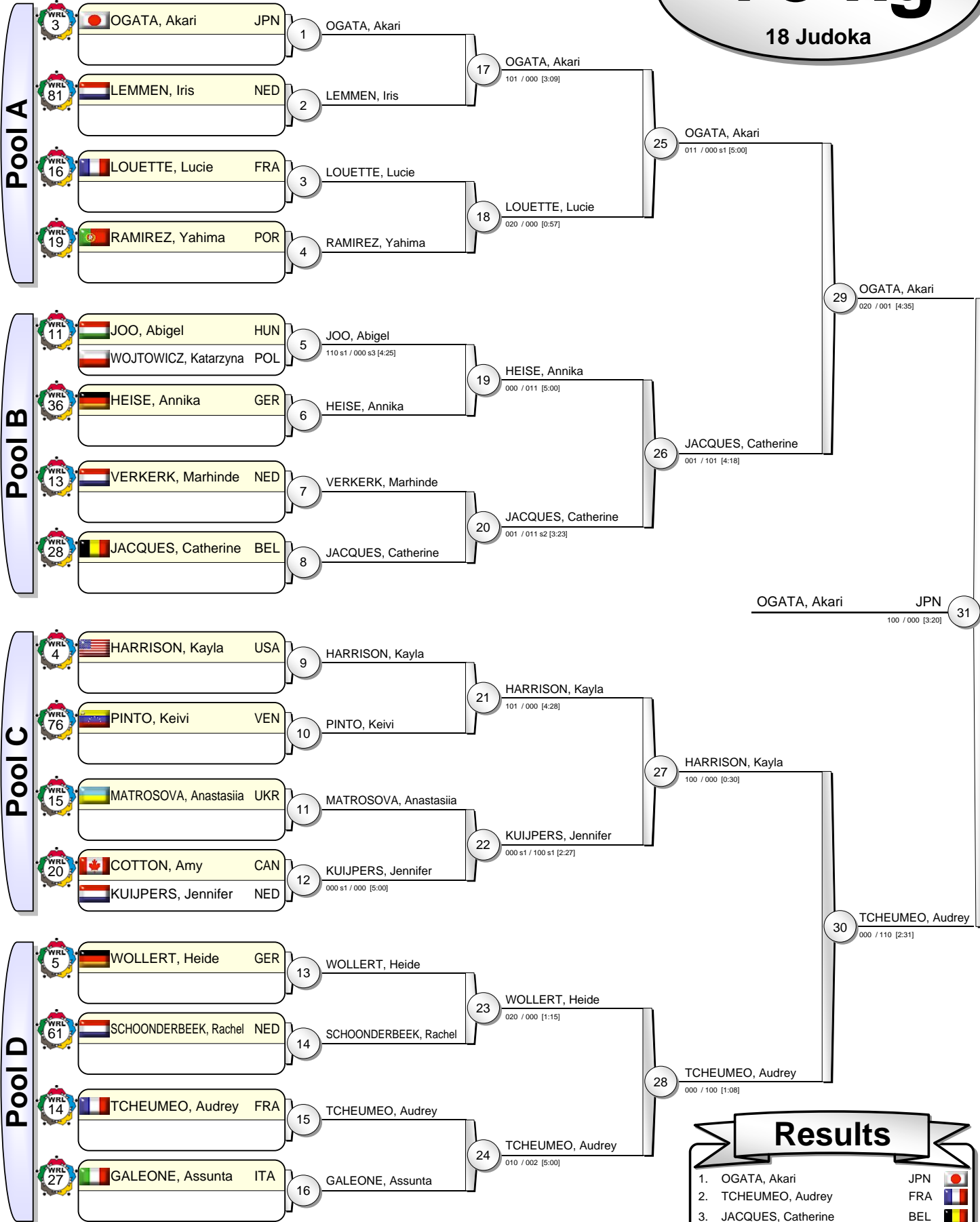

Results

- | | | |
|-----------------------|-----|--|
| 1. OGATA, Akari | JPN | |
| 2. TCHEUMEO, Audrey | FRA | |
| 3. JACQUES, Catherine | BEL | |
| 3. HARRISON, Kayla | USA | |
| 5. LOUETTE, Lucie | FRA | |
| 5. HEISE, Annika | GER | |
| 5. KUIJPERS, Jennifer | NED | |
| 5. WOLLERT, Heide | GER | |



IJF Grandprix Rotterdam 2010

(NED Rotterdam, 15-17 October 2010)

+78 kg

12 Judoka

Pool A

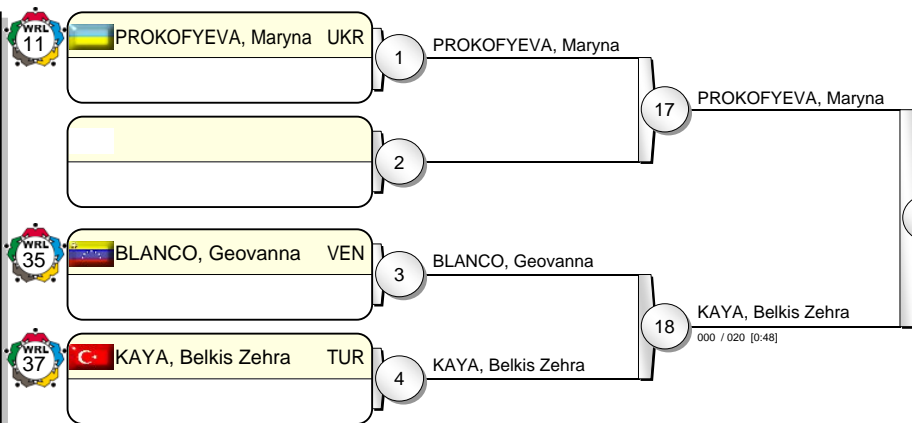

Pool B

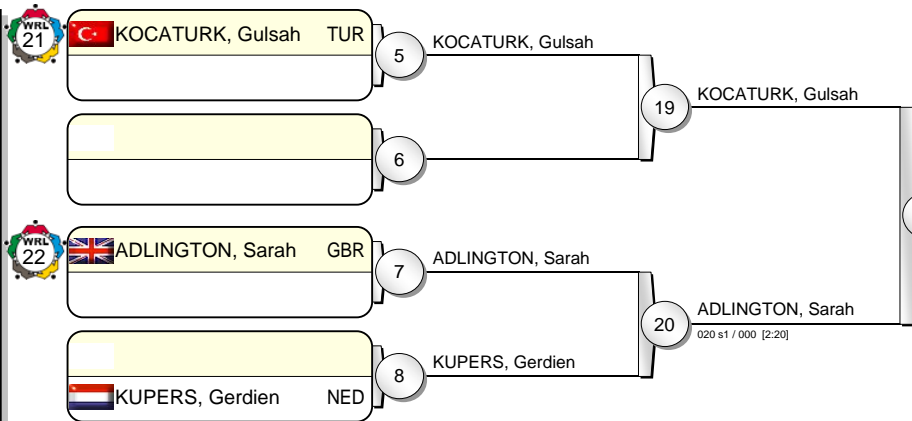

Pool C

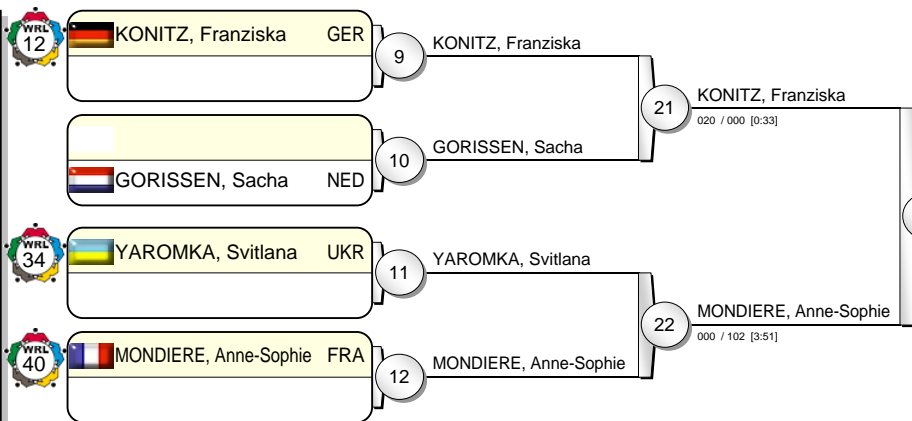

Pool D

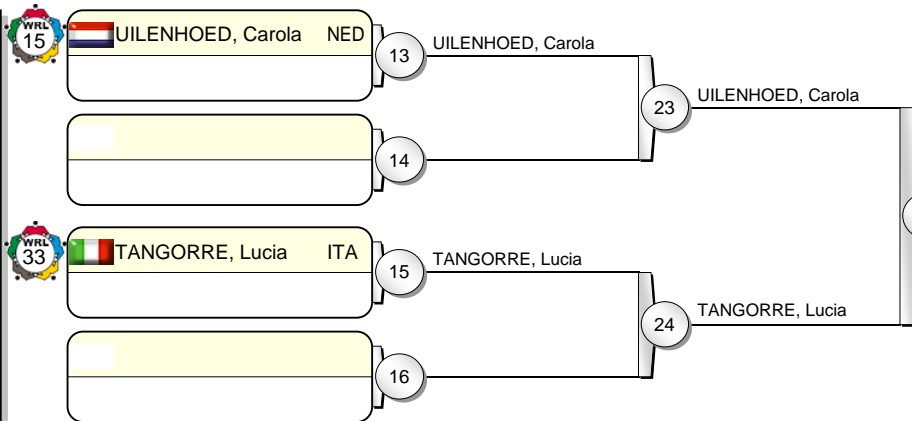

KOCATURK, Gulsah TUR (31) [1:00 / 0:00 [0:27]]

MONDIERE, Anne-Sophie (30) [0:01 / 0:00 s2 [5:00]]

Results

- | | | | |
|----|-----------------------|-----|--|
| 1. | KOCATURK, Gulsah | TUR | |
| 2. | MONDIERE, Anne-Sophie | FRA | |
| 3. | KAYA, Belkis Zehra | TUR | |
| 3. | TANGORRE, Lucia | ITA | |
| 5. | PROKOFYEVA, Maryna | UKR | |
| 5. | ADLINGTON, Sarah | GBR | |
| 5. | KONITZ, Franziska | GER | |
| 5. | UILENHOED, Carola | NED | |