



Grand Slam Moscow 2011

(RUS Moscow, 28-29 May 2011)

-60 kg

40 Judoka

Pool A

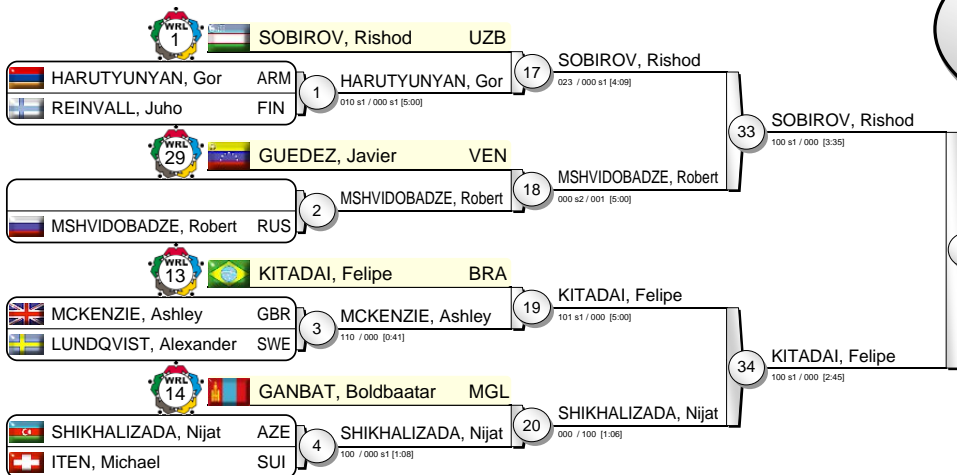

Pool B

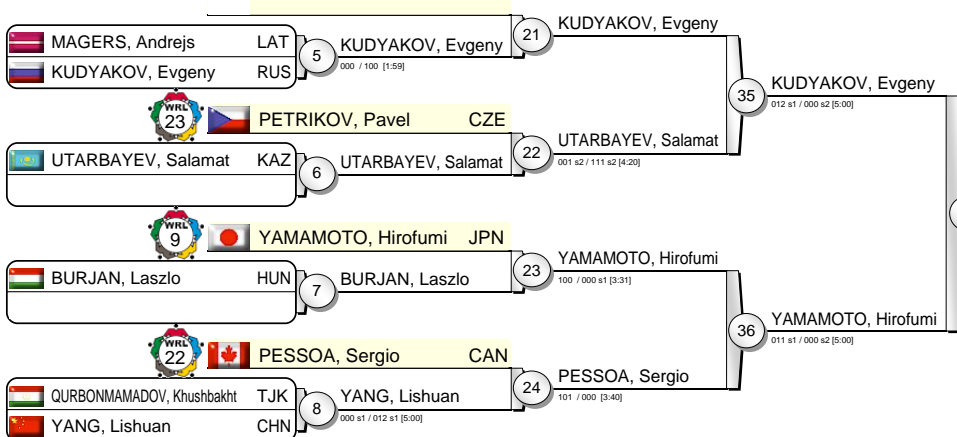

Pool C

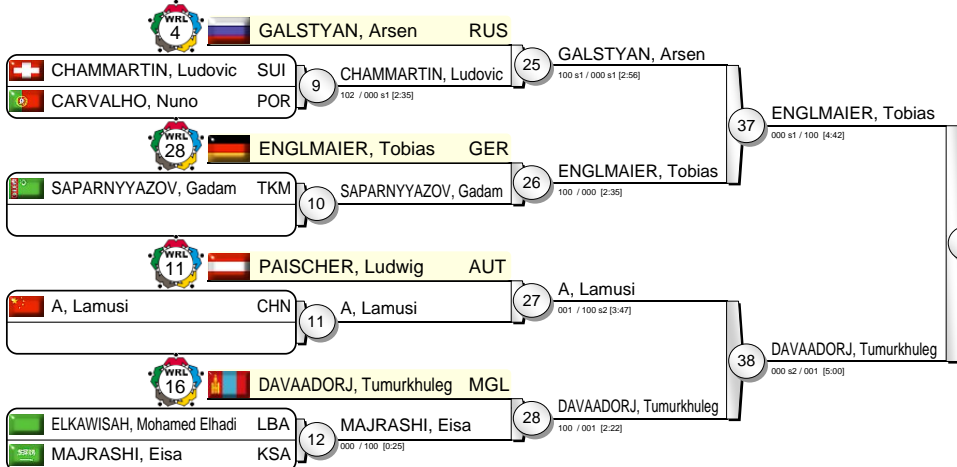

Pool D

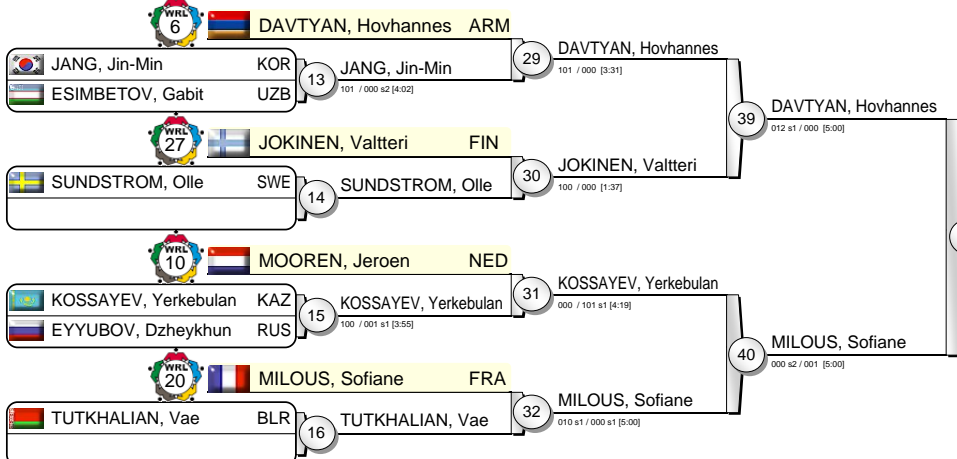

SOBIROV, Rishod
100 s1 / 000 s1 [4:54] 47

MILOUS, Sofiane
000 / 100 s1 [1:32] 46

Results

- SOBIROV, Rishod UZB
- MILOUS, Sofiane FRA
- YAMAMOTO, Hirofumi JPN
- DAVAADORJ, Tumurkhuleg MGL
- KITADAI, Felipe BRA
- KUDYAKOV, Evgeny RUS
- ENGLMAIER, Tobias GER
- DAVTYAN, Hovhannes ARM



Grand Slam Moscow 2011

(RUS Moscow, 28-29 May 2011)

-66 kg

41 Judoka

Pool A

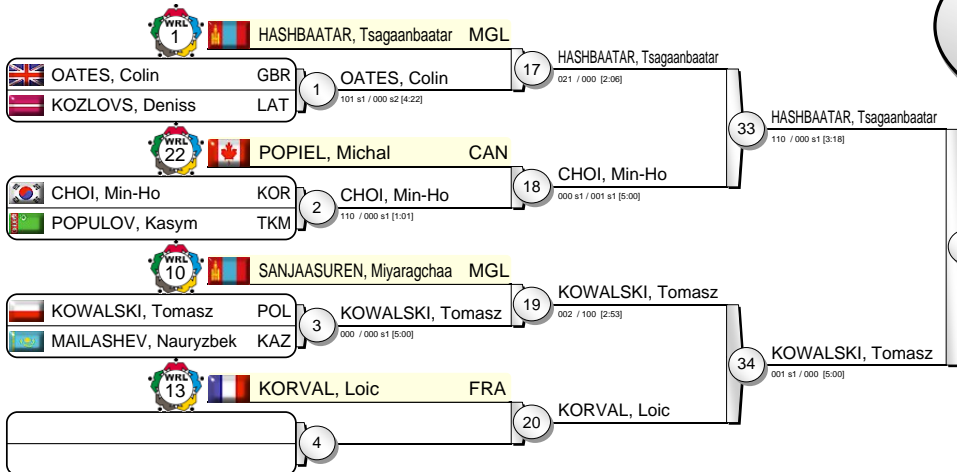

Pool B

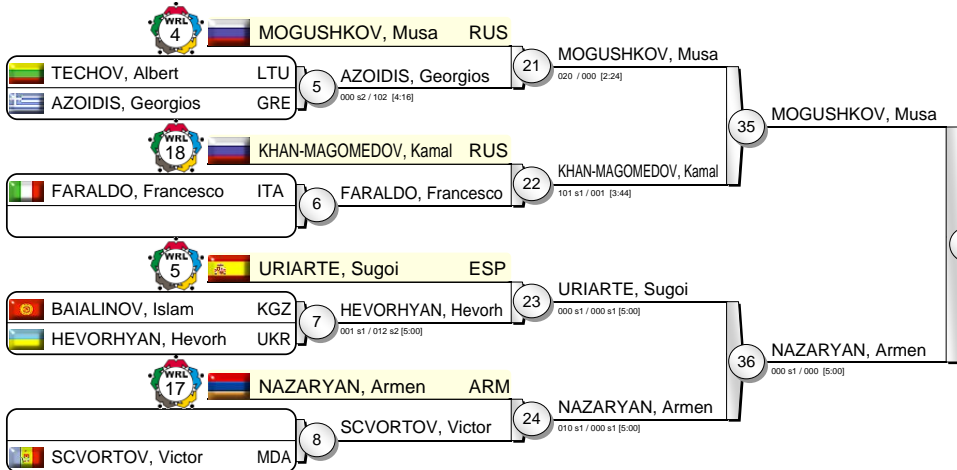

Pool C

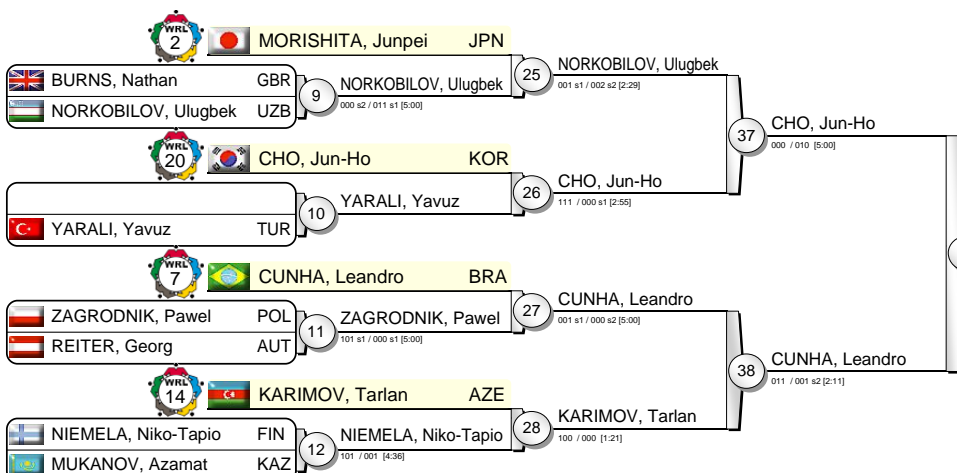

Pool D

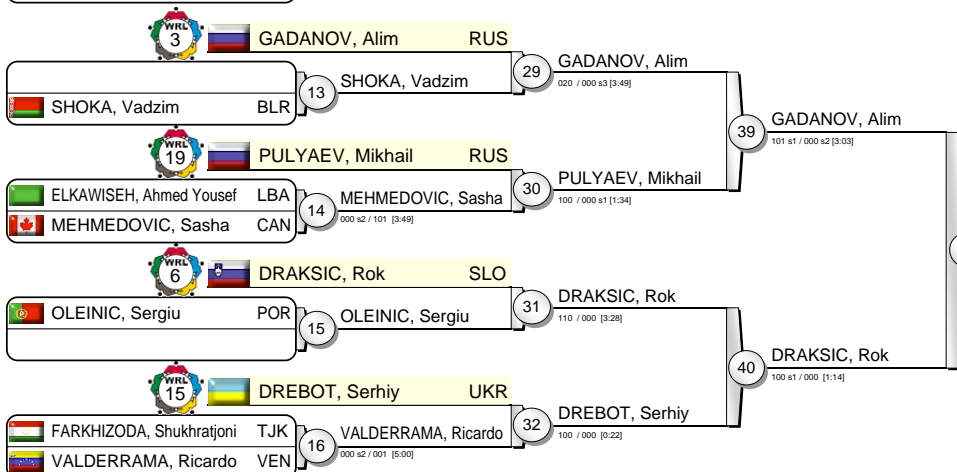

GADANOV, Alim

000 s1 / 010 (2:44)

47

GADANOV, Alim

000 s1 / 100 s1 (4:28)

46

Results

- GADANOV, Alim (RUS)
- KOWALSKI, Tomasz (POL)
- MOGUSHKOV, Musa (RUS)
- CHO, Jun-Ho (KOR)
- HASHBAATAR, Tsagaanbaatar (MGL)
- NAZARYAN, Armen (ARM)
- CUNHA, Leandro (BRA)
- DRAKSIC, Rok (SLO)



Grand Slam Moscow 2011

(RUS Moscow, 28-29 May 2011)

-73 kg

42 Judoka

Pool A

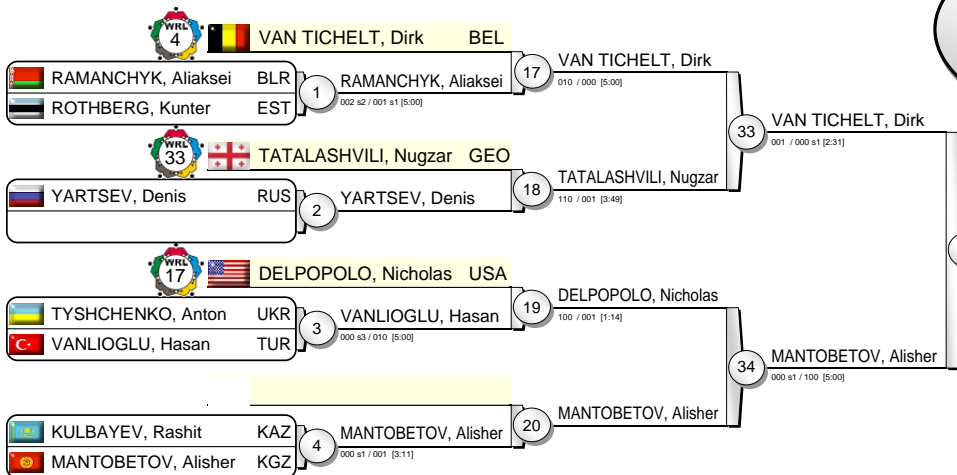

Pool B

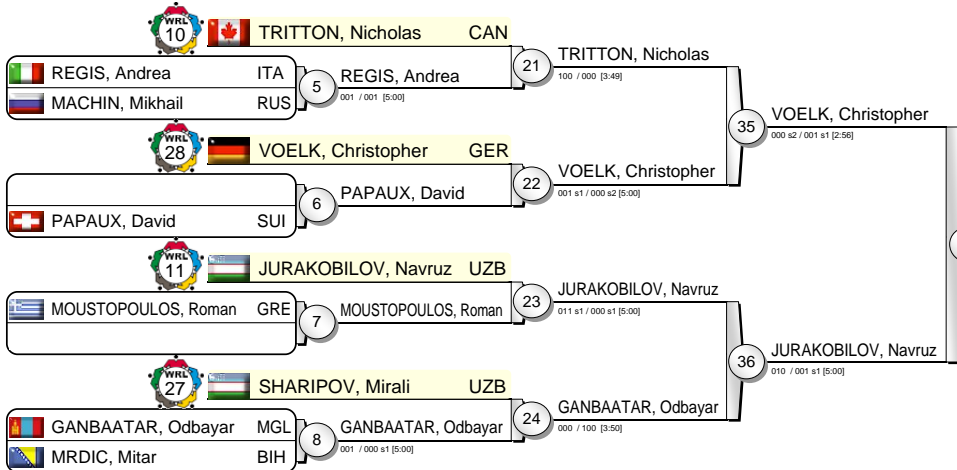

Pool C

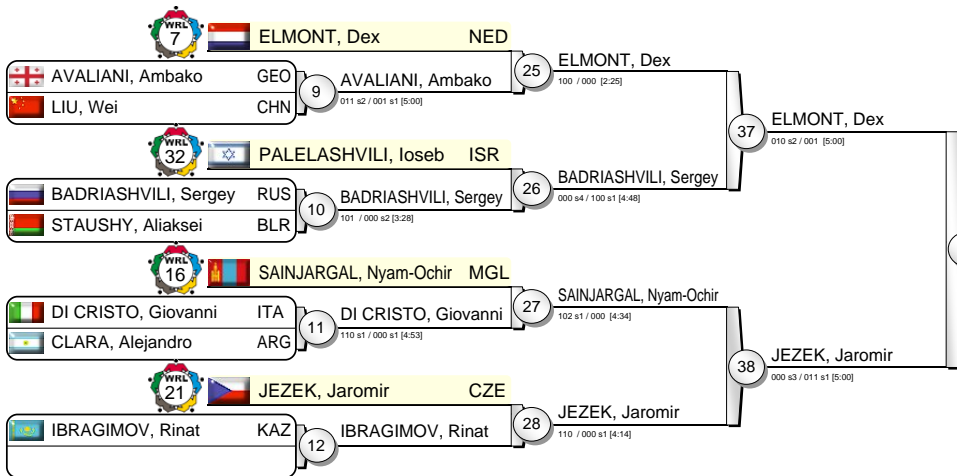

Pool D

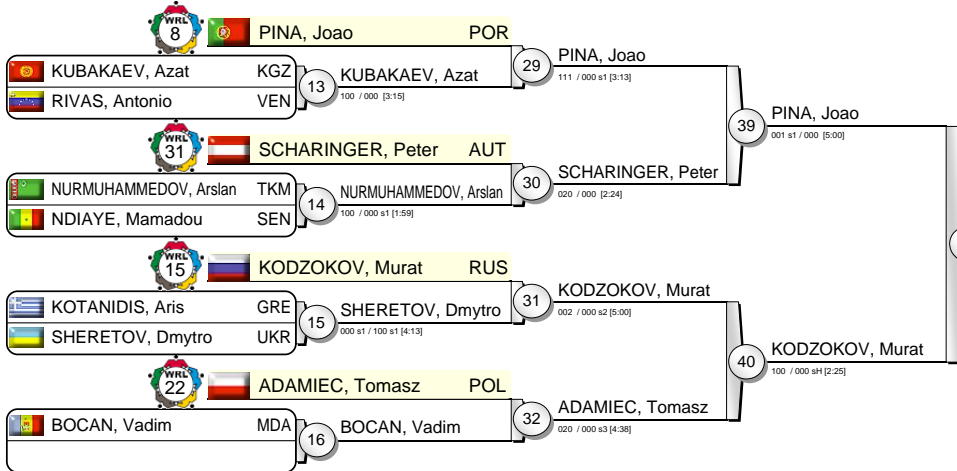

ELMONT, Dex

0:00 s2 / 0:01 s1 (5:00)

47

ELMONT, Dex

1:00 s2 / 0:01 (4:34)

46

Results

- ELMONT, Dex
- VOELK, Christopher
- VAN TICHEL, Dirk
- KODZOKOV, Murat
- MANTOBETOV, Alisher
- JURAKOBILOV, Navruz
- JEZEK, Jaromir
- PINA, Joao



Grand Slam Moscow 2011

(RUS Moscow, 28-29 May 2011)

-90 kg

40 Judoka

Pool A

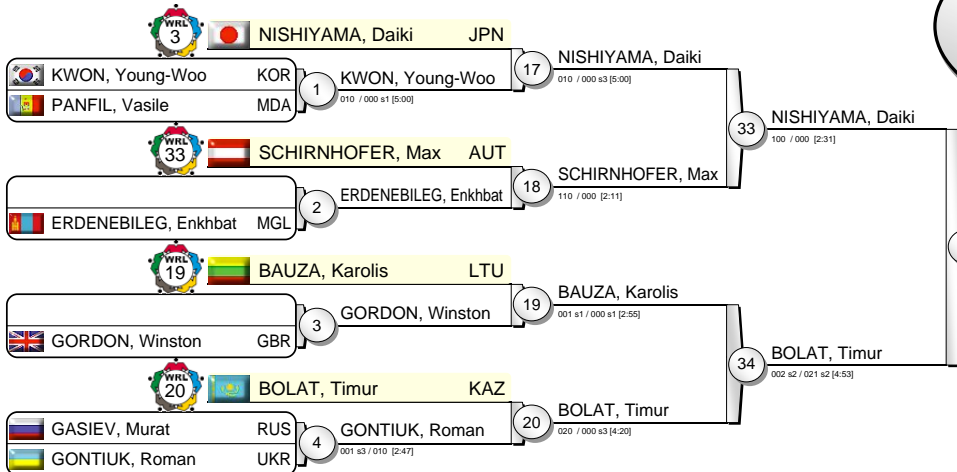

Pool B

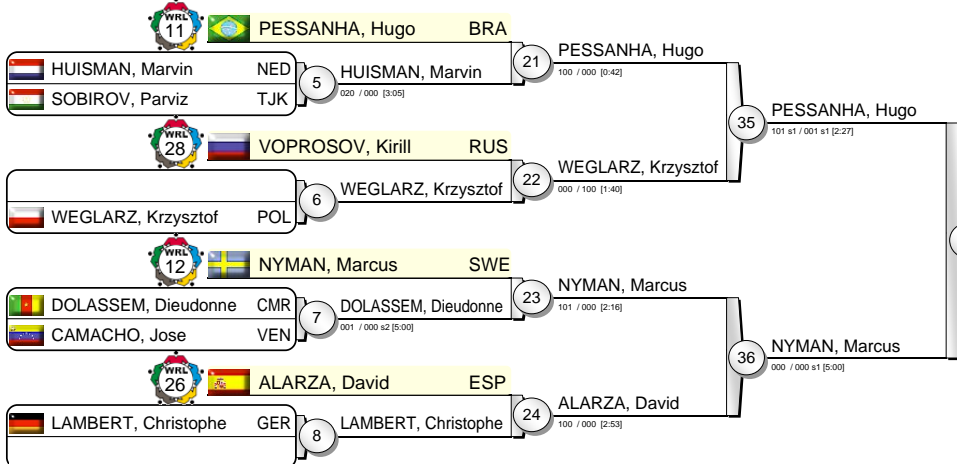

Pool C

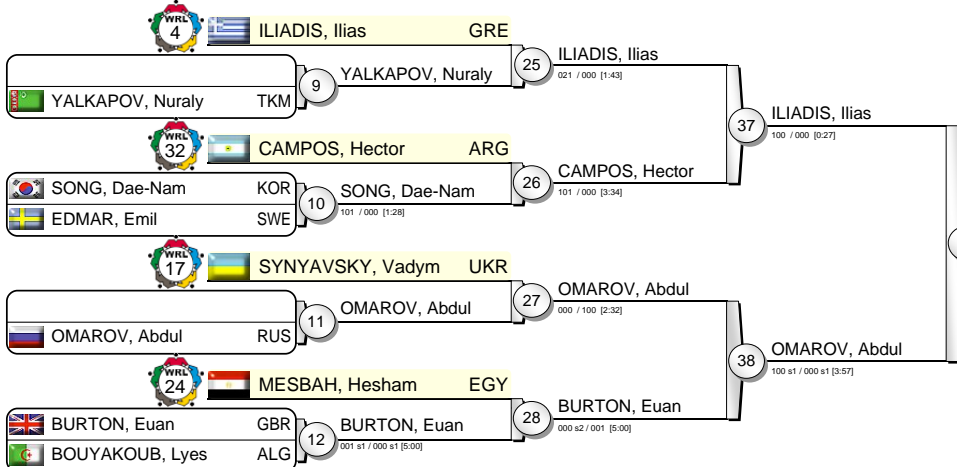

Pool D

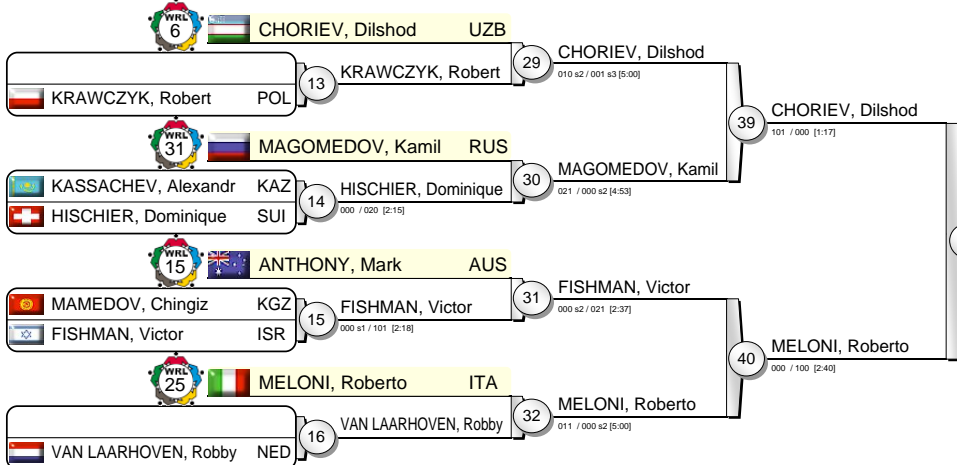

ILIADIS, Ilias

0:00 / 1:00 [0:45]

47

ILIADIS, Ilias

0:02 / 0:00 s2 [5:00]

46

Results

- | | | |
|---------------------|-----|--|
| 1. ILIADIS, Ilias | GRE | |
| 2. NISHIYAMA, Daiki | JPN | |
| 3. PESSANHA, Hugo | BRA | |
| 3. MELONI, Roberto | ITA | |
| 5. BOLAT, Timur | KAZ | |
| 5. NYMAN, Marcus | SWE | |
| 5. OMAROV, Abdul | RUS | |
| 5. CHORIEV, Dilshod | UZB | |



Grand Slam Moscow 2011

(RUS Moscow, 28-29 May 2011)

-100 kg

33 Judoka

Pool A

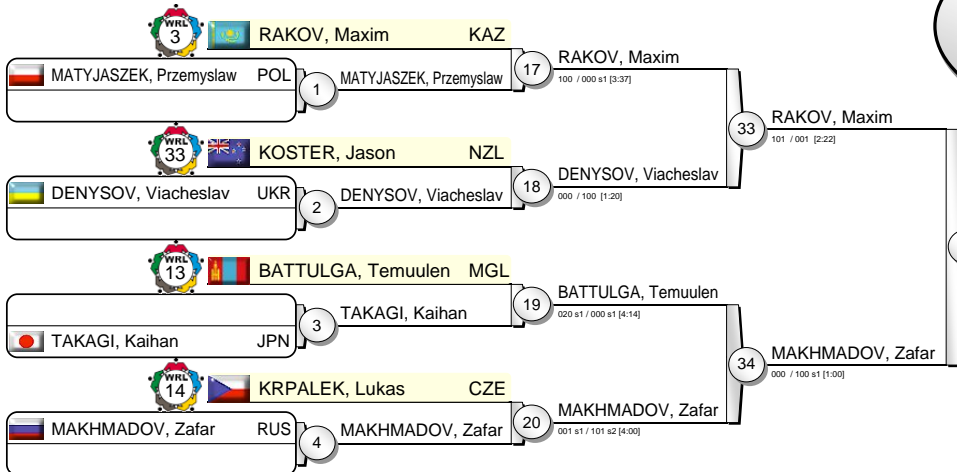

Pool B

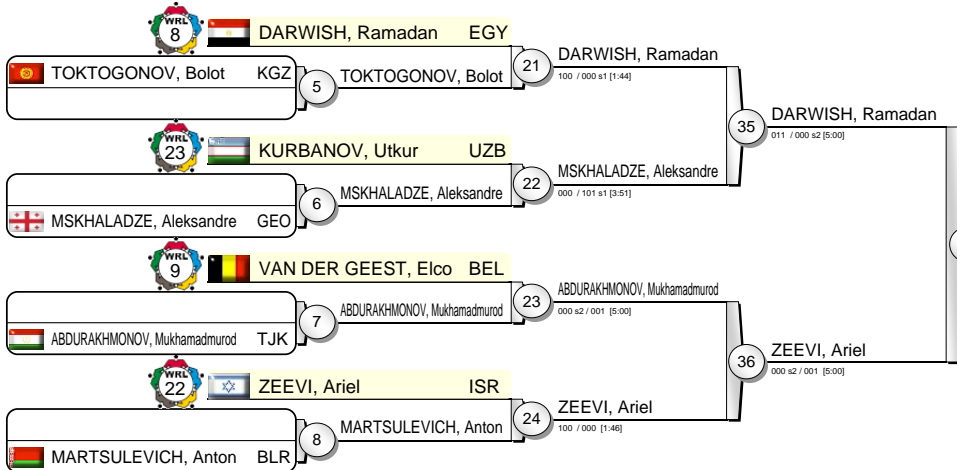

Pool C

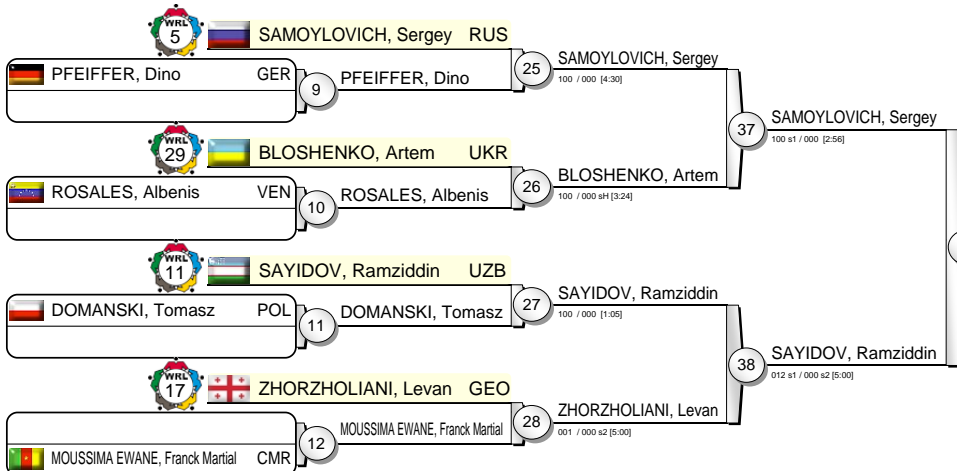

Pool D

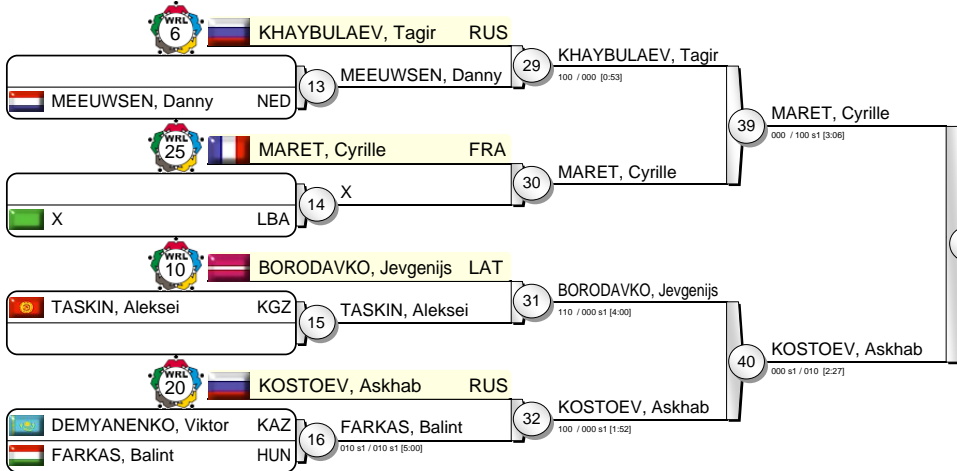

ZEEVI, Ariel

011 / 001 s1 [5:00]

47

Results

- ZEEVI, Ariel
- MARET, Cyrille
- RAKOV, Maxim
- SAYIDOV, Ramziddin
- MAKHMADOV, Zafar
- DARWISH, Ramadan
- SAMOYLOVICH, Sergey
- KOSTOEV, Askhab



Grand Slam Moscow 2011

(RUS Moscow, 28-29 May 2011)

+100 kg

32 Judoka

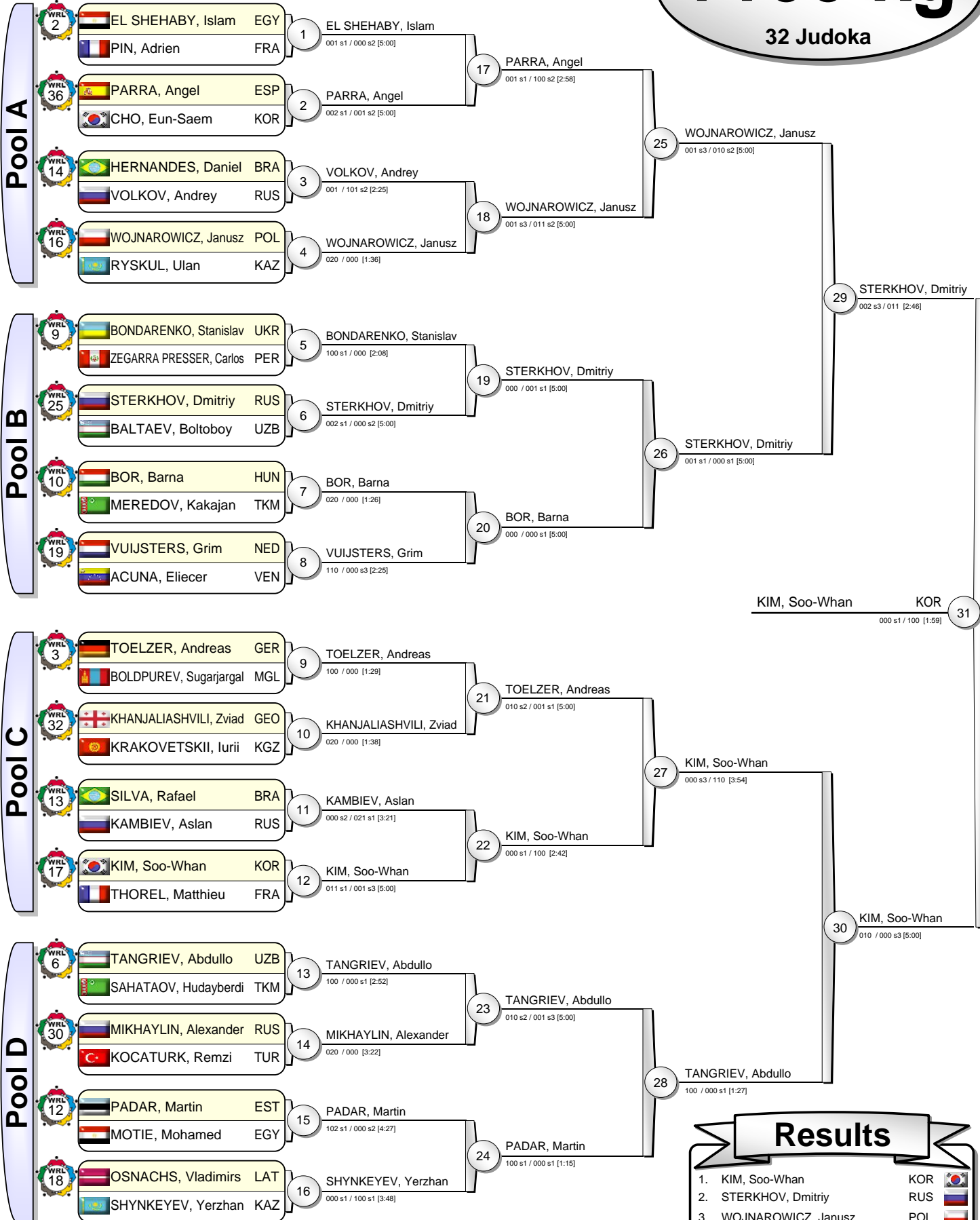

KIM, Soo-Whan KOR 31
000 s1 / 100 [1:59]

Results

- | | | |
|------------------------|-----|--|
| 1. KIM, Soo-Whan | KOR | |
| 2. STERKHOV, Dmitriy | RUS | |
| 3. WOJNAROWICZ, Janusz | POL | |
| 3. TANGRIEV, Abdullo | UZB | |
| 5. PARRA, Angel | ESP | |
| 5. BOR, Barna | HUN | |
| 5. TOELZER, Andreas | GER | |
| 5. PADAR, Martin | EST | |



Grand Slam Moscow 2011

(RUS Moscow, 28-29 May 2011)

-48 kg

29 Judoka

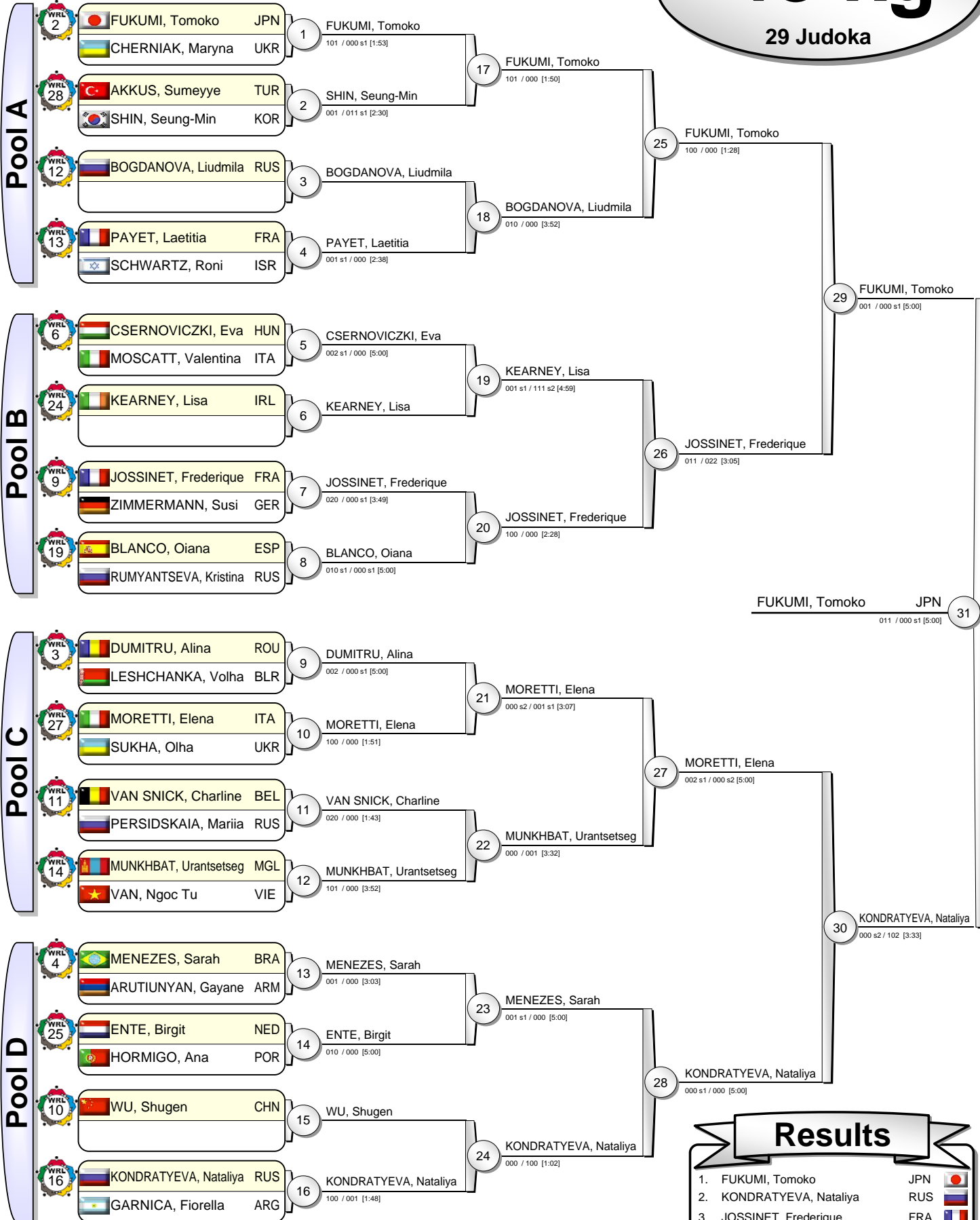

Results

- | | | |
|--------------------------|-----|--|
| 1. FUKUMI, Tomoko | JPN | |
| 2. KONDRATYEVA, Nataliya | RUS | |
| 3. JOSSINET, Frederique | FRA | |
| 3. MORETTI, Elena | ITA | |
| 5. BOGDANOVA, Liudmila | RUS | |
| 5. KEARNEY, Lisa | IRL | |
| 5. MUNKHBAT, Urantsetseg | MGL | |
| 5. MENEZES, Sarah | BRA | |



Grand Slam Moscow 2011

(RUS Moscow, 28-29 May 2011)

-52 kg

33 Judoka

Pool A

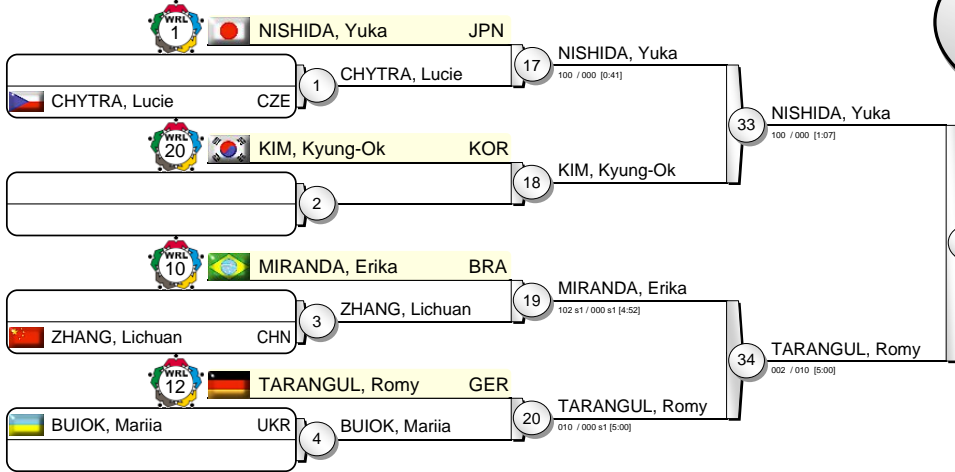

Pool B

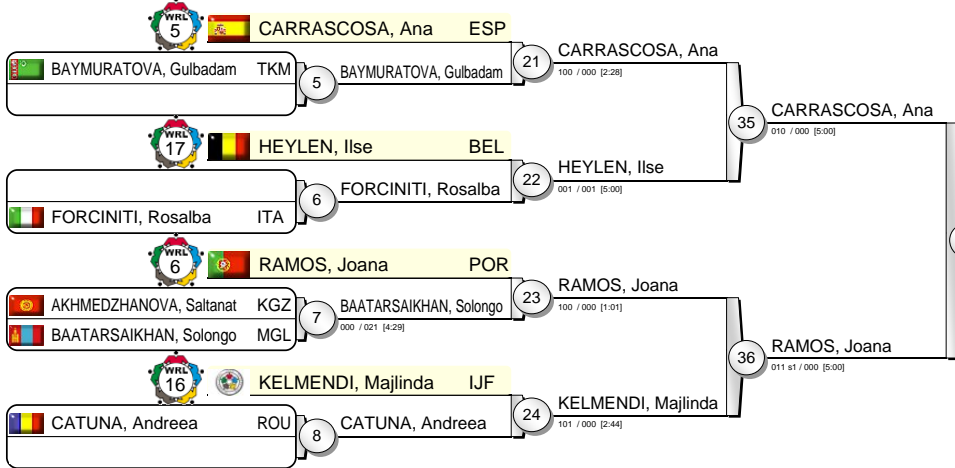

Pool C

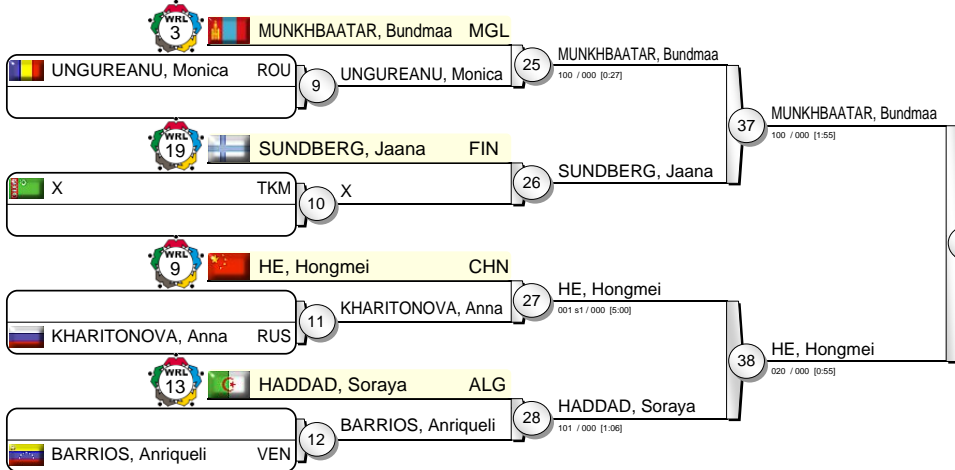

Pool D

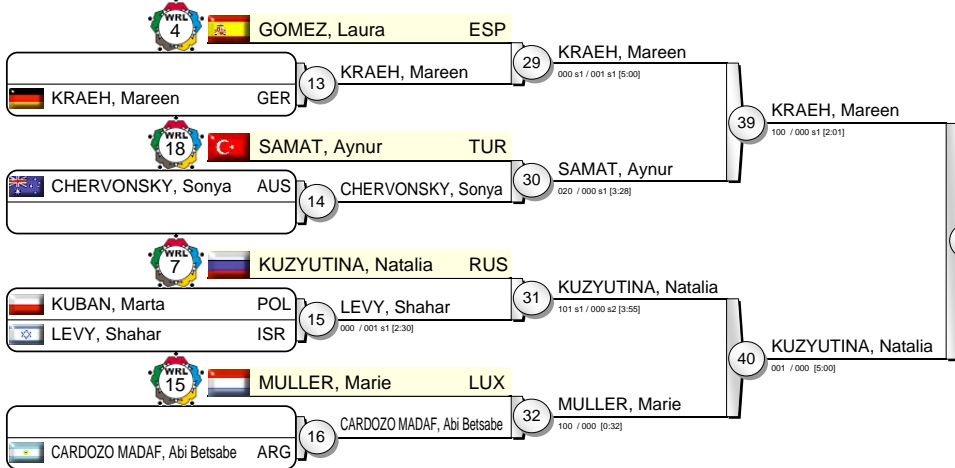

MUNKHBAATAR, Bundmaa

000 / 001 s1 [2:48]

47

Results

- MUNKHBAATAR, Bundmaa MGL
- NISHIDA, Yuka JPN
- RAMOS, Joana POR
- KUZYUTINA, Natalia RUS
- TARANGUL, Romy GER
- CARRASCOSA, Ana ESP
- HE, Hongmei CHN
- KRAEH, Mareen GER



Grand Slam Moscow 2011

(RUS Moscow, 28-29 May 2011)

-57 kg

34 Judoka

Pool A

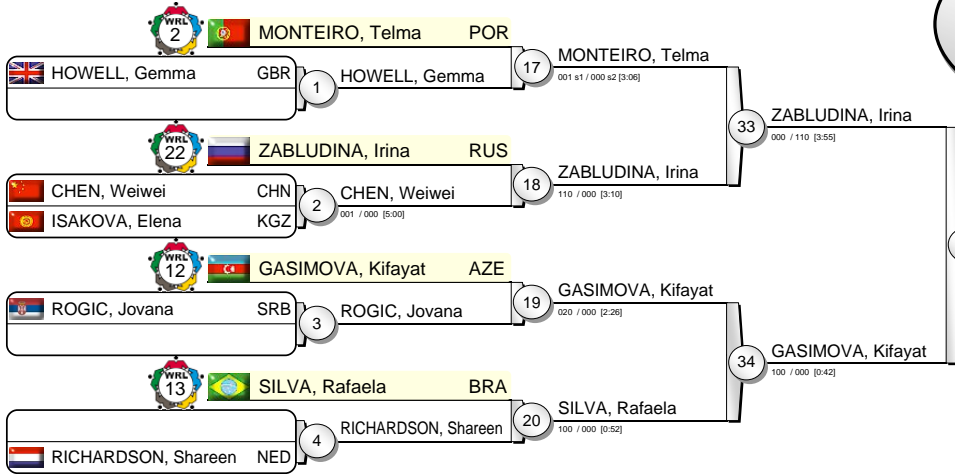

Pool B

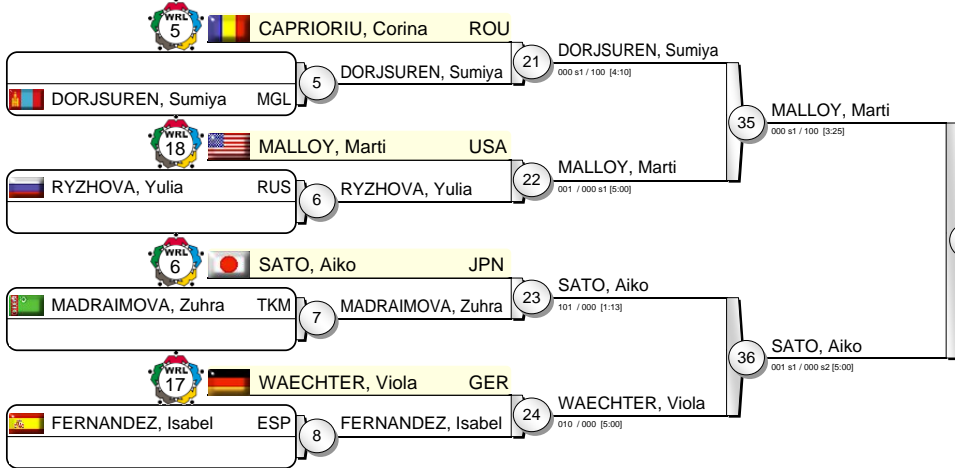

Pool C

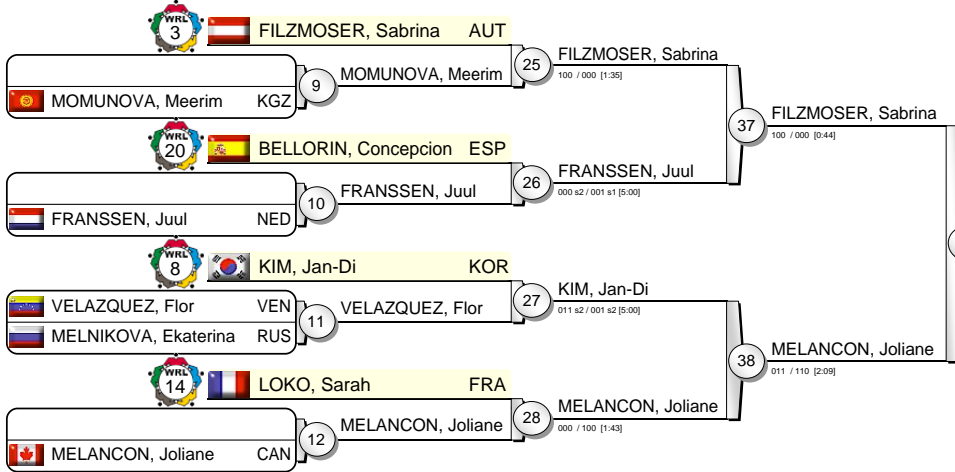

Pool D

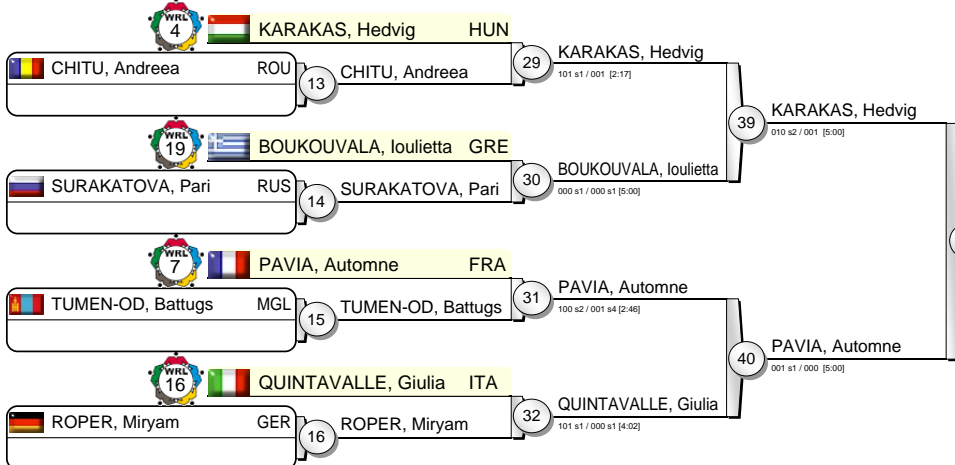

SATO, Aiko

010 s1 / 000 s1 [5:00]

47

Results

- | | | |
|-----------------------|-----|--|
| 1. SATO, Aiko | JPN | |
| 2. PAVIA, Automne | FRA | |
| 3. ZABLUDINA, Irina | RUS | |
| 3. FILZMOSER, Sabrina | AUT | |
| 5. GASIMOVA, Kifayat | AZE | |
| 5. MALLOY, Marti | USA | |
| 5. MELANCON, Joliane | CAN | |
| 5. KARAKAS, Hedvig | HUN | |



Grand Slam Moscow 2011

(RUS Moscow, 28-29 May 2011)

-63 kg

30 Judoka

Pool A

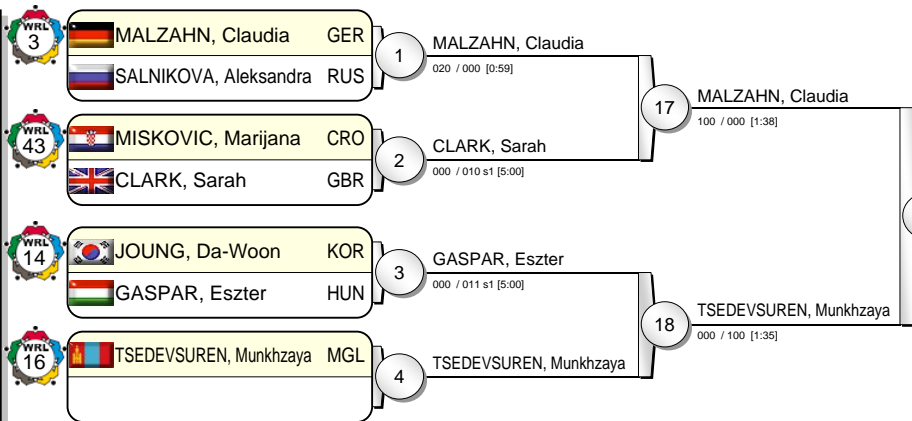

Pool B

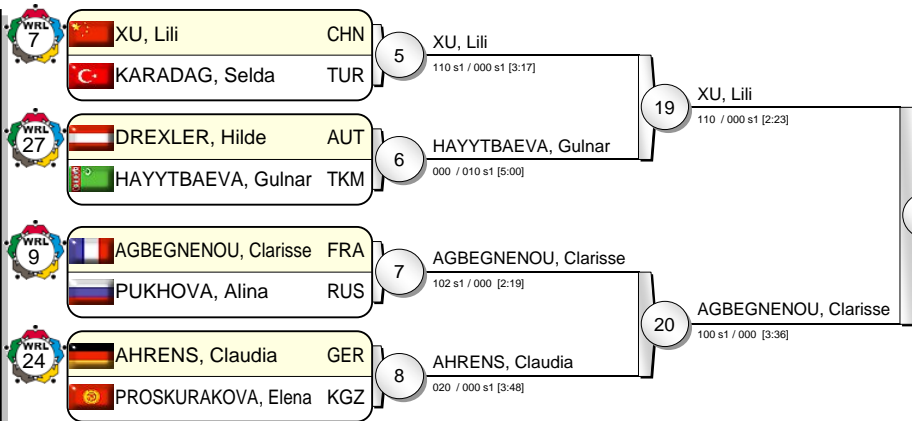

Pool C

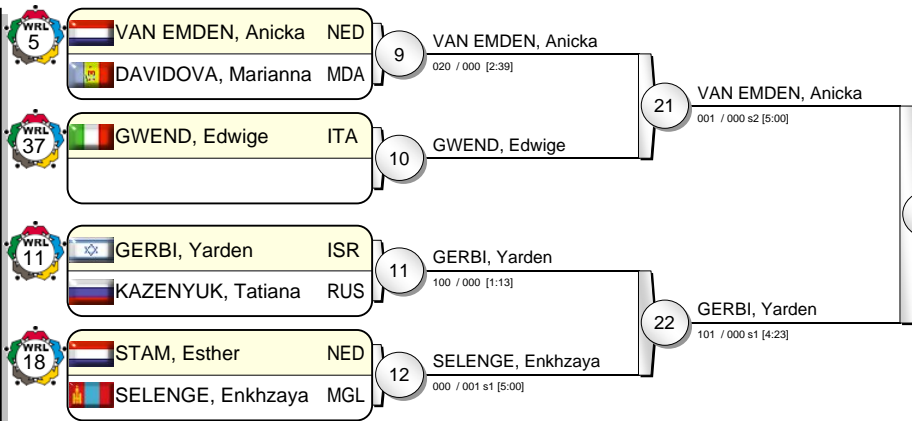

Pool D

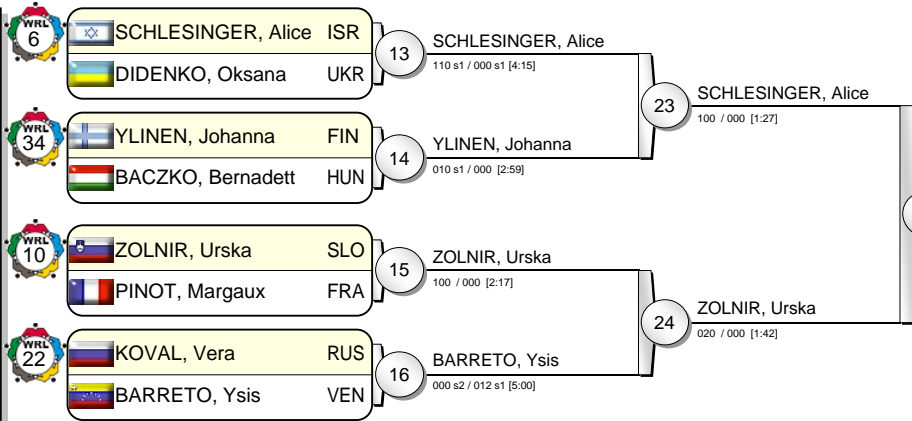

ZOLNIR, Urska (SLO) 31 (001 / 100 [3:03])

29 TSEDEVSUREN, Munkhzaya (010 s1 / 001 s1 [5:00])

26 XU, Lili (101 / 000 [2:34])

27 GERBI, Yarden (000 s1 / 000 [5:00])

30 ZOLNIR, Urska (000 / 020 [1:55])

Results

- | | | |
|---------------------------|-----|--|
| 1. ZOLNIR, Urska | SLO | |
| 2. TSEDEVSUREN, Munkhzaya | MGL | |
| 3. XU, Lili | CHN | |
| 3. GERBI, Yarden | ISR | |
| 5. MALZAHN, Claudia | GER | |
| 5. AGBEGNEOU, Clarisse | FRA | |
| 5. VAN EMDEN, Anicka | NED | |
| 5. SCHLESINGER, Alice | ISR | |



Grand Slam Moscow 2011

(RUS Moscow, 28-29 May 2011)

-70 kg

19 Judoka

Pool A

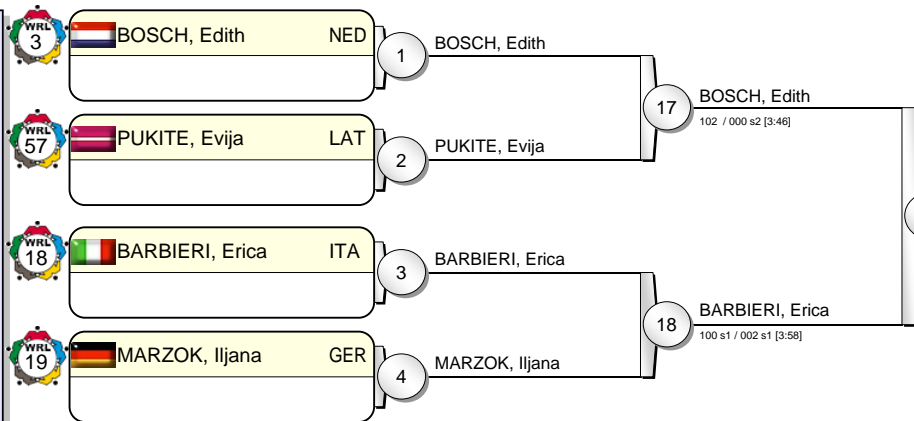

Pool B

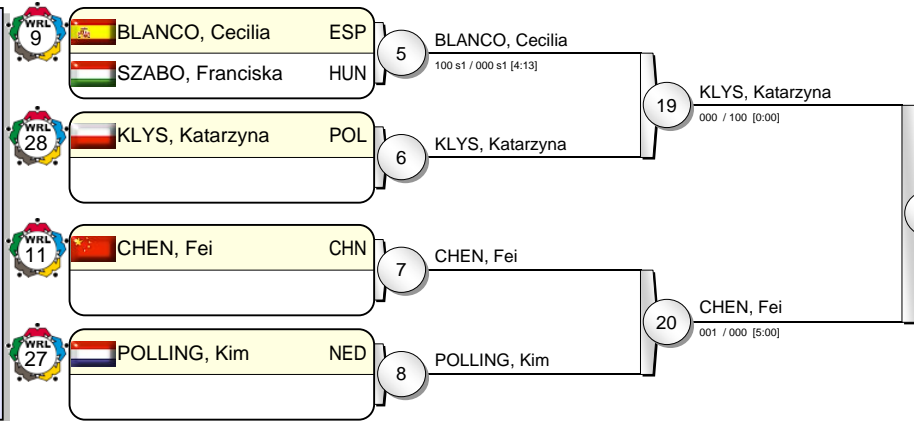

Pool C

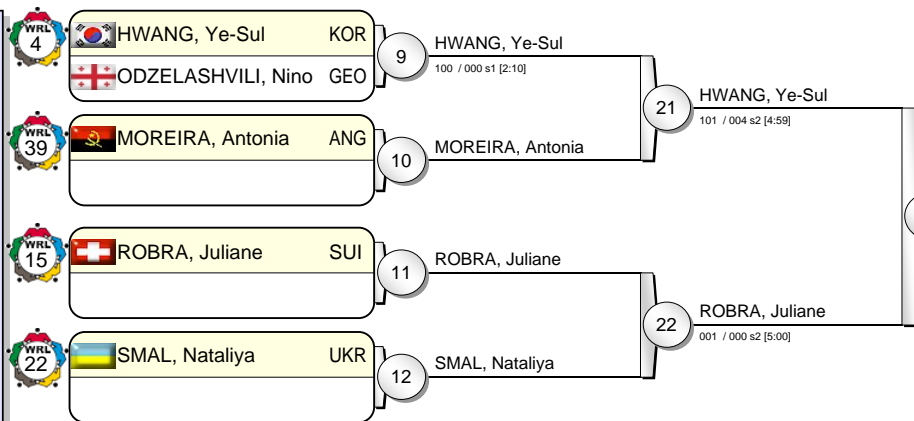

Pool D

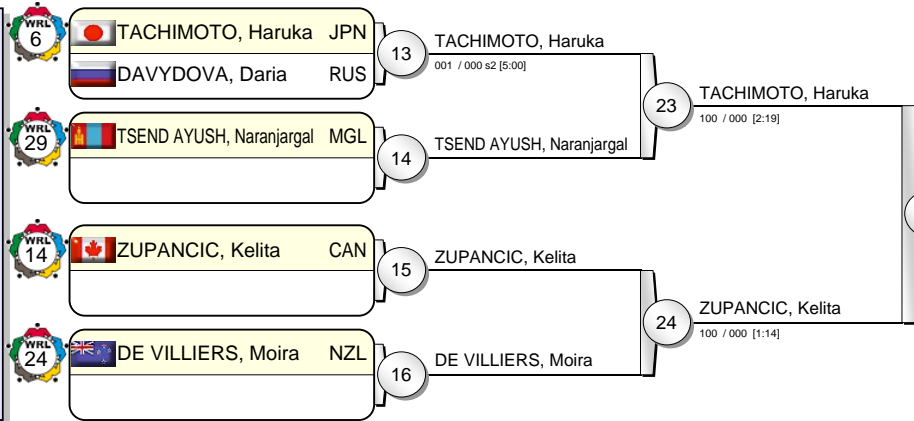

BOSCH, Edith NED 31
100 / 000 [1:55]

TACHIMOTO, Haruka 30
000 s2 / 102 [4:19]

Results

- | | | |
|----------------------|-----|--|
| 1. BOSCH, Edith | NED | |
| 2. TACHIMOTO, Haruka | JPN | |
| 3. CHEN, Fei | CHN | |
| 3. ROBRA, Juliane | SUI | |
| 5. BARBIERI, Erica | ITA | |
| 5. KLYS, Katarzyna | POL | |
| 5. HWANG, Ye-Sul | KOR | |
| 5. ZUPANCIC, Kelita | CAN | |



Grand Slam Moscow 2011

(RUS Moscow, 28-29 May 2011)

-78 kg

22 Judoka

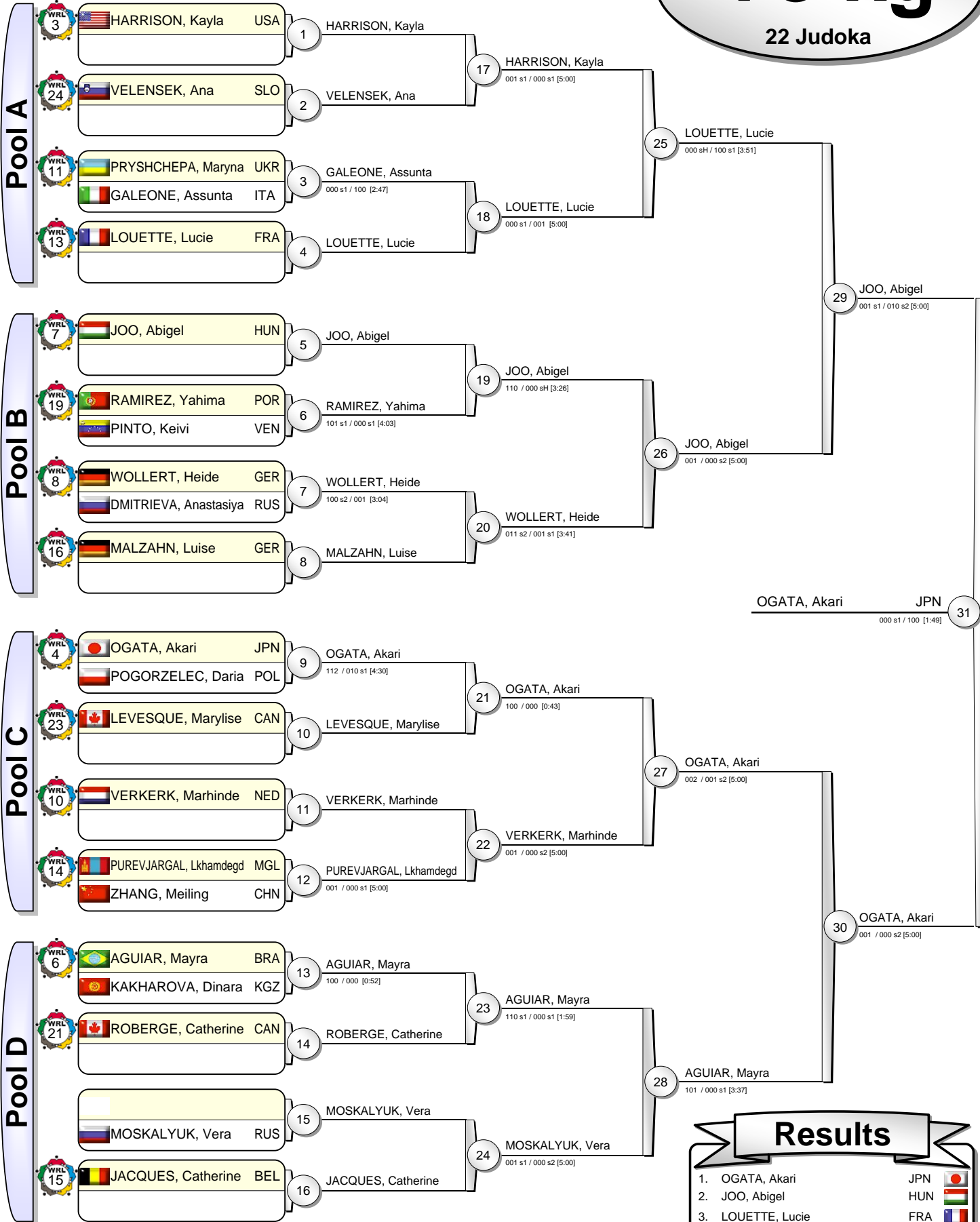

OGATA, Akari JPN 31 (000 s1 / 100 [1:49])

OGATA, Akari 30 (001 / 000 s2 [5:00])

Results

- | | | |
|----------------------|-----|--|
| 1. OGATA, Akari | JPN | |
| 2. JOO, Abigel | HUN | |
| 3. LOUETTE, Lucie | FRA | |
| 3. AGUIAR, Mayra | BRA | |
| 5. HARRISON, Kayla | USA | |
| 5. WOLLERT, Heide | GER | |
| 5. VERKERK, Marhinde | NED | |
| 5. MOSKALYUK, Vera | RUS | |



Grand Slam Moscow 2011

(RUS Moscow, 28-29 May 2011)

+78 kg

15 Judoka

Pool A

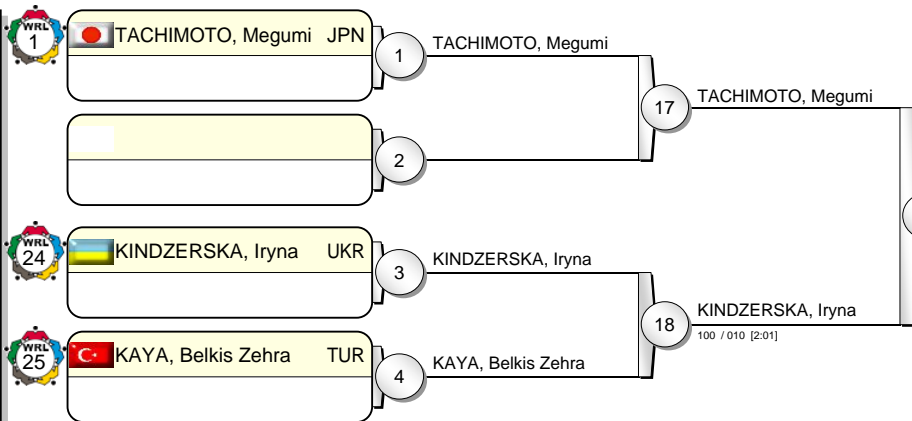

Pool B

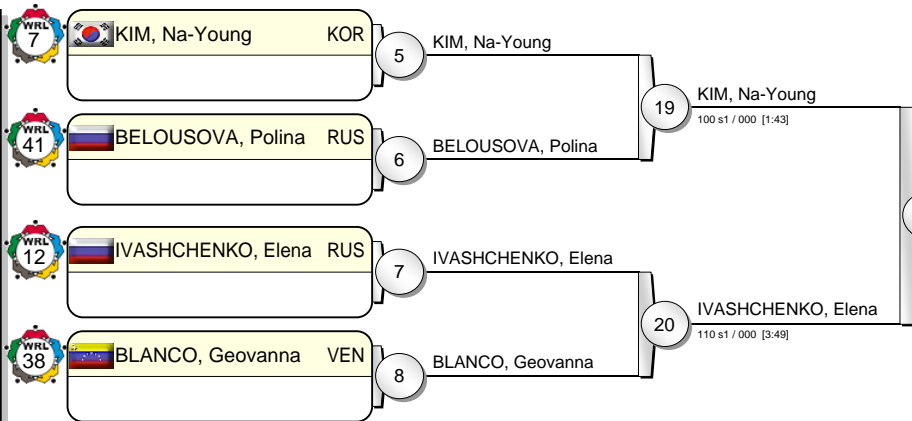

Pool C

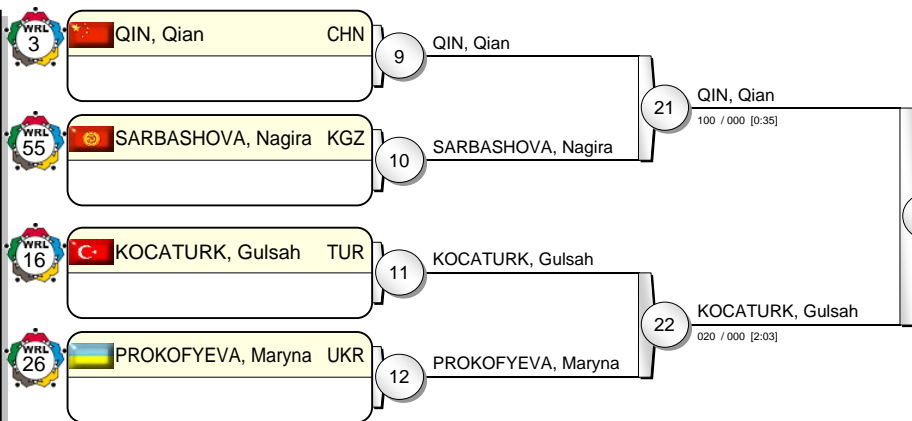

Pool D

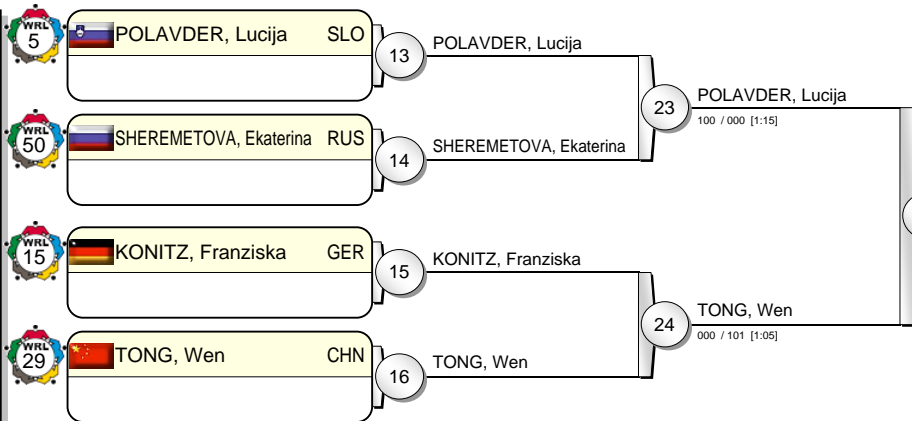

TONG, Wen CHN 31
000 s1 / 100 [2:31]

29 KIM, Na-Young
000 / 010 [5:00]

25 TACHIMOTO, Megumi
010 / 000 [5:00]

26 KIM, Na-Young
100 s1 / 000 s4 [3:31]

27 KOCATURK, Gulsah
000 / 020 [0:39]

28 TONG, Wen
000 / 100 [0:26]

30 TONG, Wen
000 / 100 [1:25]

Results

- | | | |
|-----------------------|-----|--|
| 1. TONG, Wen | CHN | |
| 2. KIM, Na-Young | KOR | |
| 3. TACHIMOTO, Megumi | JPN | |
| 3. KOCATURK, Gulsah | TUR | |
| 5. KINDZERSKA, Iryna | UKR | |
| 5. IVASHCHENKO, Elena | RUS | |
| 5. QIN, Qian | CHN | |
| 5. POLAVDER, Lucija | SLO | |